

MPEG2 Main Profile Decoder on HDVICP2 and Media Controller Based Platform

User's Guide



Literature Number: SPRUH45
July 2014

IMPORTANT NOTICE

Texas Instruments Incorporated and its subsidiaries (TI) reserve the right to make corrections, enhancements, improvements and other changes to its semiconductor products and services per JESD46, latest issue, and to discontinue any product or service per JESD48, latest issue. Buyers should obtain the latest relevant information before placing orders and should verify that such information is current and complete. All semiconductor products (also referred to herein as "components") are sold subject to TI's terms and conditions of sale supplied at the time of order acknowledgment.

TI warrants performance of its components to the specifications applicable at the time of sale, in accordance with the warranty in TI's terms and conditions of sale of semiconductor products. Testing and other quality control techniques are used to the extent TI deems necessary to support this warranty. Except where mandated by applicable law, testing of all parameters of each component is not necessarily performed.

TI assumes no liability for applications assistance or the design of Buyers' products. Buyers are responsible for their products and applications using TI components. To minimize the risks associated with Buyers' products and applications, Buyers should provide adequate design and operating safeguards.

TI does not warrant or represent that any license, either express or implied, is granted under any patent right, copyright, mask work right, or other intellectual property right relating to any combination, machine, or process in which TI components or services are used. Information published by TI regarding third-party products or services does not constitute a license to use such products or services or a warranty or endorsement thereof. Use of such information may require a license from a third party under the patents or other intellectual property of the third party, or a license from TI under the patents or other intellectual property of TI.

Reproduction of significant portions of TI information in TI data books or data sheets is permissible only if reproduction is without alteration and is accompanied by all associated warranties, conditions, limitations, and notices. TI is not responsible or liable for such altered documentation. Information of third parties may be subject to additional restrictions.

Resale of TI components or services with statements different from or beyond the parameters stated by TI for that component or service voids all express and any implied warranties for the associated TI component or service and is an unfair and deceptive business practice. TI is not responsible or liable for any such statements.

Buyer acknowledges and agrees that it is solely responsible for compliance with all legal, regulatory and safety-related requirements concerning its products, and any use of TI components in its applications, notwithstanding any applications-related information or support that may be provided by TI. Buyer represents and agrees that it has all the necessary expertise to create and implement safeguards which anticipate dangerous consequences of failures, monitor failures and their consequences, lessen the likelihood of failures that might cause harm and take appropriate remedial actions. Buyer will fully indemnify TI and its representatives against any damages arising out of the use of any TI components in safety-critical applications.

In some cases, TI components may be promoted specifically to facilitate safety-related applications. With such components, TI's goal is to help enable customers to design and create their own end-product solutions that meet applicable functional safety standards and requirements. Nonetheless, such components are subject to these terms.

No TI components are authorized for use in FDA Class III (or similar life-critical medical equipment) unless authorized officers of the parties have executed a special agreement specifically governing such use.

Only those TI components which TI has specifically designated as military grade or "enhanced plastic" are designed and intended for use in military/aerospace applications or environments. Buyer acknowledges and agrees that any military or aerospace use of TI components which have **not** been so designated is solely at the Buyer's risk, and that Buyer is solely responsible for compliance with all legal and regulatory requirements in connection with such use.

TI has specifically designated certain components as meeting ISO/TS16949 requirements, mainly for automotive use. In any case of use of non-designated products, TI will not be responsible for any failure to meet ISO/TS16949.

Products

Audio	www.ti.com/audio
Amplifiers	amplifier.ti.com
Data Converters	dataconverter.ti.com
DLP® Products	www.dlp.com
DSP	dsp.ti.com
Clocks and Timers	www.ti.com/clocks
Interface	interface.ti.com logic.ti.com
Power Mgmt	power.ti.com
Microcontrollers	microcontroller.ti.com
RFID	www.ti-rfid.com
OMAP Applications Processors	www.ti.com/omap
Wireless Connectivity	www.ti.com/wirelessconnectivity

Applications

Automotive and Transportation	www.ti.com/automotive
Communications and Telecom	www.ti.com/communications
Computers and Peripherals	www.ti.com/computers
Consumer Electronics	www.ti.com/consumer-apps
Energy and Lighting	www.ti.com/energy
Industrial	www.ti.com/industrial
Medical	www.ti.com/medical Logic
Security	www.ti.com/security
Space, Avionics and Defense	www.ti.com/space-avionics-defense
Video and Imaging	www.ti.com/video

TI E2E Community

e2e.ti.com

Mailing Address: Texas Instruments, Post Office Box 655303, Dallas, Texas 75265

Copyright © 2014, Texas Instruments Incorporated

Preface

Read This First

About This Manual

This document describes how to install and work with Texas Instruments' (TI) MPEG2 Main Profile Decoder implementation on the HDVICP2 and Media Controller based platform. It also provides a detailed Application Programming Interface (API) reference and information on the sample application that accompanies this component.

TI's codec implementations are based on the eXpressDSP Digital Media (XDM) standard. XDM is an extension of the eXpressDSP Algorithm Interface Standard (XDAIS).

Intended Audience

This document is intended for system engineers who want to integrate TI's codecs with other software to build a multimedia system based on the HDVICP2 based platform.

This document assumes that you are fluent in the C language, have a good working knowledge of Digital Signal Processing (DSP), digital signal processors, and DSP applications. Good knowledge of eXpressDSP Algorithm Interface Standard (XDAIS) and eXpressDSP Digital Media (XDM) standard will be helpful.

How to Use This Manual

This document includes the following chapters:

- ❑ **Chapter 1 - Introduction**, provides a brief introduction to the XDAIS and XDM standards. It also provides an overview of the codec and lists its supported features.
- ❑ **Chapter 2 - Installation Overview**, describes how to install, build, and run the codec.
- ❑ **Chapter 3 - Sample Usage**, describes the sample usage of the codec.
- ❑ **Chapter 4 - API Reference**, describes the data structures and interface functions used in the codec.
- ❑ **Chapter 5 – Frequently Asked Questions**, answers few frequently asked questions related to using MPEG2 Main Profile Decoder on HDVICP2 and Media Controller Based Platform.
- ❑ **Chapter 6 – Picture Format**, provides information on format of YUV buffers provided to decoder.

- ❑ **Chapter 7 – Debug Trace Usage**, describes the debug trace feature supported by the codec and its usage.
- ❑ **Chapter 8 – Error Handling**, explains the error handling and error robustness features of this MPEG-2 Decoder.

Related Documentation From Texas Instruments

The following documents describe TI's DSP algorithm standards such as, XDAIS and XDM. To obtain a copy of any of these TI documents, visit the Texas Instruments website at www.ti.com.

- ❑ *TMS320 DSP Algorithm Standard Rules and Guidelines* (literature number SPRU352) defines a set of requirements for DSP algorithms that, if followed, allow system integrators to quickly assemble production-quality systems from one or more such algorithms.
- ❑ *TMS320 DSP Algorithm Standard API Reference* (literature number SPRU360) describes all the APIs that are defined by the TMS320 DSP Algorithm Interface Standard (also known as XDAIS) specification.
- ❑ *Technical Overview of eXpressDSP - Compliant Algorithms for DSP Software Producers* (literature number SPRA579) describes how to make algorithms compliant with the TMS320 DSP Algorithm Standard which is part of TI's eXpressDSP technology initiative.
- ❑ *Using the TMS320 DSP Algorithm Standard in a Static DSP System* (literature number SPRA577) describes how an eXpressDSP-compliant algorithm may be used effectively in a static system with limited memory.
- ❑ *eXpressDSP Digital Media (XDM) Standard API Reference* (literature number SPRUEC8)
- ❑ *Using IRES and RMAN Framework Components for C64x+* (literature number SPRAAI5), describes the IRES interface definition and function calling sequence

Related Documentation

You can use the following documents to supplement this user guide:

- ❑ ISO/IEC-13838-2: Information Technology- Generic coding of moving pictures and associated audio information: Video

Abbreviations

The following abbreviations are used in this document.

Table 0-1. List of Abbreviations

Abbreviation	Description
BIOS	TI's simple RTOS for DSPs

Abbreviation	Description
CSL	Chip Support Library
D1	720x480 or 720x576 resolutions in progressive scan
DCT	Discrete Cosine Transform
DMA	Direct Memory Access
DMAN	DMA Manager
DPB	Decoded Picture Buffer
EVM	Evaluation Module
HDTV	High Definition Television
IRES	Interface standard to request and receive handles to resources
ISO	International Standards Organization
HDVICP2	Image Video Accelerator
MB	Macro Block
MPEG	Moving Pictures Experts Group
MV	Motion Vector
NAL	Network Adaptation Layer
NTSC	National Television Standards Committee
RMAN	Resource Manager
RTOS	Real Time Operating System
VCL	Video Coding Layer
VGA	Video Graphics Array (640 x 480 resolution)
VOP	Video Object Plane
XDAIS	eXpressDSP Algorithm Interface Standard
XDM	eXpressDSP Digital Media
YUV	Color space in luminance and chrominance form

Text Conventions

The following conventions are used in this document:

- Text inside back-quotes (“”) represents pseudo-code.
- Program source code, function and macro names, parameters, and command line commands are shown in a `mono-spaced` font.

Product Support

When contacting TI for support on this codec, quote the product name (MPEG2 Main Profile Decoder on HDVICP2) and version number. The version number of the codec is included in the title of the Release Notes that accompanies this codec.

Trademarks

Code Composer Studio, DSP/BIOS, eXpressDSP, TMS320, HDVICP2, are trademarks of Texas Instruments.

All trademarks are the property of their respective owners.

This page is intentionally left blank

Contents

READ THIS FIRST	III
ABOUT THIS MANUAL	III
INTENDED AUDIENCE	III
HOW TO USE THIS MANUAL	III
RELATED DOCUMENTATION FROM TEXAS INSTRUMENTS	IV
RELATED DOCUMENTATION	IV
ABBREVIATIONS	IV
TEXT CONVENTIONS	VI
PRODUCT SUPPORT	VI
TRADEMARKS	VI
CONTENTS	VIII
FIGURES	X
TABLES	XII
INTRODUCTION	1-1
1.1 OVERVIEW OF XDAIS AND XDM	1-2
1.1.1 XDAIS Overview	1-2
1.1.2 XDM Overview	1-3
1.1.3 IRES Overview	1-4
1.2 OVERVIEW OF MPEG2 MAIN PROFILE DECODER	1-5
1.3 SUPPORTED SERVICES AND FEATURES	1-6
INSTALLATION OVERVIEW	2-1
2.1 SYSTEM REQUIREMENTS	2-2
2.1.1 Hardware	2-2
2.1.2 Software	2-2
2.2 INSTALLING THE COMPONENT	2-3
2.3 BEFORE BUILDING THE SAMPLE TEST APPLICATION	2-4
2.4 BUILDING AND RUNNING THE SAMPLE TEST APPLICATION	2-6
2.4.1 Building the Sample Test Application	2-6
2.4.2 Running the Sample Test Application on Netra HDVICP2 Simulator	2-6
2.4.3 Running the Sample Test Application on DM816x EVM	2-7
2.5 CONFIGURATION FILES	2-8
2.5.1 Generic Configuration File	2-8
2.5.2 Decoder Configuration File	2-9
2.6 UNINSTALLING THE COMPONENT	2-10
SAMPLE USAGE	3-1
3.1 OVERVIEW OF THE TEST APPLICATION	3-2
3.1.1 Parameter Setup	3-3
3.1.2 Algorithm Instance Creation and Initialization	3-3
3.1.3 Process Call	3-4

3.1.4	<i>Algorithm Instance Deletion</i>	3-6
3.2	FRAME BUFFER MANAGEMENT BY APPLICATION	3-6
3.2.1	<i>Frame Buffer Input and Output</i>	3-6
3.2.2	<i>Frame Buffer Format</i>	3-7
3.2.3	<i>Frame Buffer Management by Application</i>	3-7
3.3	HANDSHAKING BETWEEN APPLICATION AND ALGORITHM	3-8
3.4	ADDRESS TRANSLATIONS	3-10
3.5	SAMPLE TEST APPLICATION	3-10
API REFERENCE		4-1
4.1	SYMBOLIC CONSTANTS AND ENUMERATED DATA TYPES	4-2
4.2	DATA STRUCTURES	4-25
4.2.1	<i>Common XDM Data Structures</i>	4-25
4.2.2	<i>MPEG2 Decoder Data Structures</i>	4-39
4.3	INTERFACE FUNCTIONS.....	4-43
4.3.1	<i>Creation APIs</i>	4-44
4.3.2	<i>Initialization API</i>	4-46
4.3.3	<i>Control API</i>	4-47
4.3.4	<i>Data Processing API</i>	4-48
4.3.5	<i>Termination API</i>	4-52
FREQUENTLY ASKED QUESTIONS		5-1
5.1	CODE BUILD AND EXECUTION	5-1
5.2	ISSUES WITH TOOLS VERSION	5-1
5.3	ALGORITHM RELATED	5-1
PICTURE FORMAT		6-1
6.1	NV12 CHROMA FORMAT	6-1
6.2	PROGRESSIVE PICTURE FORMAT.....	6-2
6.3	INTERLACED PICTURE FORMAT.....	6-4
6.4	CONSTRAINTS ON BUFFER ALLOCATION FOR DECODER	6-6
DEBUG TRACE USAGE		7-1
7.1	INTRODUCTION	7-1
7.2	ENABLING AND USING DEBUG INFORMATION	7-1
7.2.1	<i>debugTracelevel</i>	7-2
7.2.2	<i>lastNFramesToLog</i>	7-2
7.3	DEBUG TRACE LEVELS	7-3
7.4	REQUIREMENTS ON THE APPLICATION	7-3
ERROR CONCEALMENT USAGE.....		8-1
8.1	INTRODUCTION	8-1
8.2	ENABLING AND USING ERROR CONCEALMENT	8-1
8.2.1	<i>ErrorConcealmentON</i>	8-2
8.2.2	<i>Transcode Mode</i>	8-2
8.2.3	<i>MetaData Type</i>	8-2
8.3	METADATA BUFFER REQUIREMENT	8-2
8.4	REQUIREMENTS ON THE APPLICATION	8-3
ERROR HANDLING.....		9-1
9.1	DESCRIPTION.....	9-1

Figures

FIGURE 1-1. IRES INTERFACE DEFINITION AND FUNCTION CALLING SEQUENCE	1-5
FIGURE 1-2. FLOW DIAGRAM OF THE MPEG2 DECODER.....	1-5
FIGURE 2-1. COMPONENT DIRECTORY STRUCTURE	2-3
FIGURE 3-1. TEST APPLICATION SAMPLE IMPLEMENTATION	3-2
FIGURE 3-2. PROCESS CALL WITH HOST RELEASE	3-5
FIGURE 3-3. INTERACTION OF FRAME BUFFERS BETWEEN APPLICATION AND FRAMEWORK	3-7
FIGURE 3-4. INTERACTION BETWEEN APPLICATION AND CODEC	3-9

This page is intentionally left blank

Tables

TABLE 0-1. LIST OF ABBREVIATIONS	IV
TABLE 2-1. COMPONENT DIRECTORIES	2-4
TABLE 4-1. LIST OF ENUMERATED DATA TYPES	4-2
TABLE 9-1 ERROR CODES USED TO SET THE EXTENDEDERROR FIELD IN IVIDDEC3_OUTARGS AND IVIDDEC3_STATUS	9-1
TABLE 9-2 ERROR CODES USED TO SET THE EXTENDEDERRORCODE0 ,EXTENDEDERRORCODE1, EXTENDEDERRORCODE2 AND EXTENDEDERRORCODE3 FIELDS IN IMPEG2VDEC_STATUS	9-3

Introduction

This chapter provides a brief introduction to XDAIS and XDM. It also provides an overview of TI's implementation of the MPEG2 Main Profile Decoder on the HDVICP2 and Media Controller based platform and its supported features.

Topic	Page
1.1 Overview of XDAIS and XDM	1-2
1.2 Overview of MPEG2 Main Profile Decoder	1-5
1.3 Supported Services and Features	1-6

1.1 Overview of XDAIS and XDM

TI's multimedia codec implementations are based on the eXpressDSP Digital Media (XDM) standard. XDM is an extension of the eXpressDSP Algorithm Interface Standard (XDAIS).

1.1.1 XDAIS Overview

An eXpressDSP-compliant algorithm is a module that implements the abstract interface IALG. The IALG API takes the memory management function away from the algorithm and places it in the hosting framework. Thus, an interaction occurs between the algorithm and the framework. This interaction allows the client application to allocate memory for the algorithm and also share memory between algorithms. It also allows the memory to be moved around while an algorithm is operating in the system. In order to facilitate these functionalities, the IALG interface defines the following APIs:

- ❑ `algAlloc()`
- ❑ `algInit()`
- ❑ `algActivate()`
- ❑ `algDeactivate()`
- ❑ `algFree()`

The `algAlloc()` API allows the algorithm to communicate its memory requirements to the client application. The `algInit()` API allows the algorithm to initialize the memory allocated by the client application. The `algFree()` API allows the algorithm to communicate the memory to be freed when an instance is no longer required.

Once an algorithm instance object is created, it can be used to process data in real-time. The `algActivate()` API provides a notification to the algorithm instance that one or more algorithm processing methods is about to be run zero or more times in succession. After the processing methods have been run, the client application calls the `algDeactivate()` API prior to reusing any of the instance's scratch memory.

The IALG interface also defines three more optional APIs `algControl()`, `algNumAlloc()`, and `algMoved()`. For more details on these APIs, see *TMS320 DSP Algorithm Standard API Reference* (literature number SPRU360).

1.1.2 XDM Overview

In the multimedia application space, you have the choice of integrating any codec into your multimedia system. For example, if you are building a video decoder system, you can use any of the available video decoders (such as MPEG4, H.263, or MPEG-2) in your system. To enable easy integration with the client application, it is important that all codecs with similar functionality use similar APIs. XDM was primarily defined as an extension to XDAIS to ensure uniformity across different classes of codecs (for example audio, video, image, and speech). The XDM standard defines the following two APIs:

- `control()`
- `process()`

The `control()` API provides a standard way to control an algorithm instance and receive status information from the algorithm in real-time. The `control()` API replaces the `algControl()` API defined as part of the IALG interface. The `process()` API does the basic processing (encode/decode) of data.

Apart from defining standardized APIs for multimedia codecs, XDM also standardizes the generic parameters that the client application must pass to these APIs. The client application can define additional implementation specific parameters using extended data structures.

The following figure depicts the XDM interface to the client application.

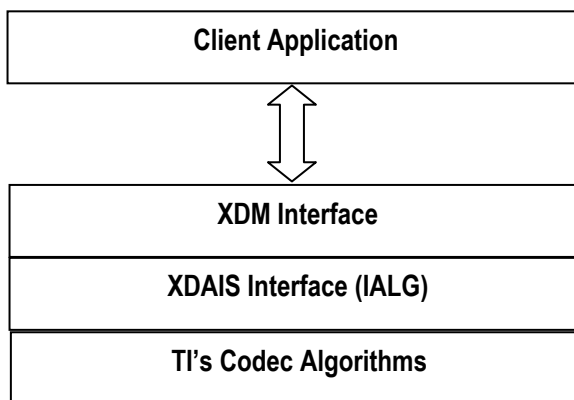

As depicted in the figure, XDM is an extension to XDAIS and forms an interface between the client application and the codec component. XDM insulates the client application from component-level changes. Since TI's multimedia algorithms are XDM compliant, it provides you with the flexibility to use any TI algorithm without changing the client application code. For example, if you have developed a client application using an XDM-compliant MPEG4 video decoder, then you can easily replace MPEG4 with another XDM-compliant video decoder, say H.263, with minimal changes to the client application.

For more details, see *eXpressDSP Digital Media (XDM) Standard API Reference* (literature number SPRUEC8).

1.1.3 IRES Overview

IRES is a generic, resource-agnostic, extendible resource query, initialization and activation interface. The application framework defines, implements, and supports concrete resource interfaces in the form of IRES extensions. Each algorithm implements the generic IRES interface, to request one or more concrete IRES resources. IRES defines standard interface functions that the framework uses to query, initialize, activate/deactivate and reallocate concrete IRES resources. To create an algorithm instance within an application framework, the algorithm and the application framework agrees on the concrete IRES resource types that are requested. The framework calls the IRES interface functions, in addition to the IALG functions, to perform IRES resource initialization, activation, and deactivation.

The IRES interface introduces support for a new standard protocol for cooperative preemption, in addition to the IALG-style non-cooperative sharing of scratch resources. Co-operative preemption allows activated algorithms to yield to higher priority tasks sharing common scratch resources. Framework components include the following modules and interfaces to support algorithms requesting IRES-based resources:

- ❑ **IRES** - Standard interface allowing the client application to query and provide the algorithm with its requested IRES resources.
- ❑ **RMAN** - Generic IRES-based resource manager, which manages and grants concrete IRES resources to algorithms and applications. RMAN uses a new standard interface, the IRESMAN, to support run-time registration of concrete IRES resource managers.

Client applications call the algorithm's IRES interface functions to query its concrete IRES resource requirements. If the requested IRES resource type matches a concrete IRES resource interface supported by the application framework, and if the resource is available, the client grants the algorithm logical IRES resource handles representing the allotted resources. Each handle provides the algorithm with access to the resource as defined by the concrete IRES resource interface.

IRES interface definition and function calling sequence is depicted in the following figure. For more details, see *Using IRES and RMAN Framework Components for C64x+* (literature number SPRAAI5).

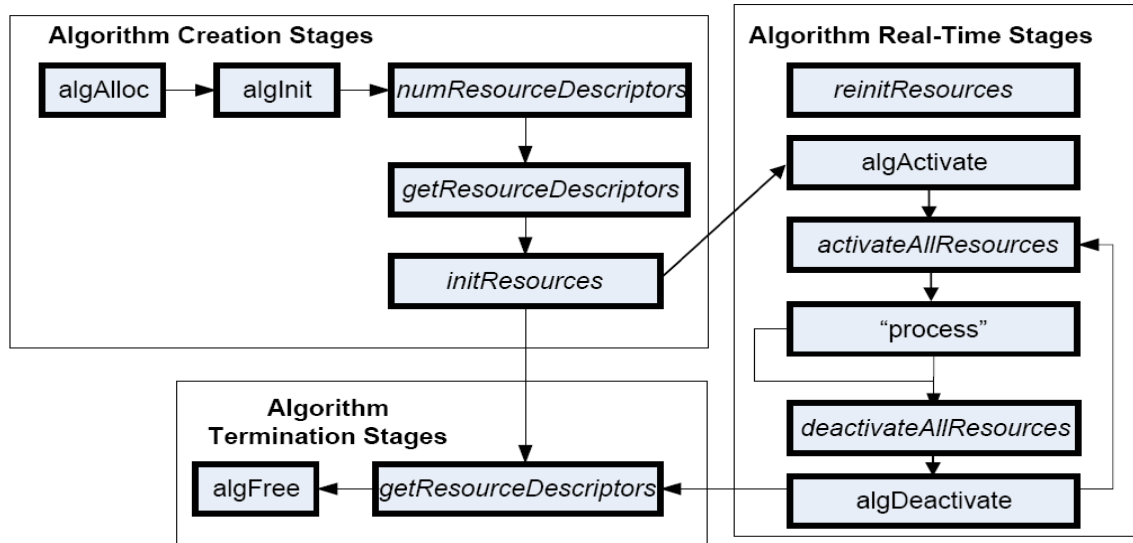

Figure 1-1. IRES Interface Definition and Function Calling Sequence

For more details, see *Using IRES and RMAN Framework Components for C64x+* (literature number SPRAAI5).

1.2 Overview of MPEG2 Main Profile Decoder

MPEG-2 is a widely used video compression algorithm that uses motion compensated prediction, Discrete Cosine Transform (DCT) coding of the prediction error signal and modified Huffman entropy coding.

Please refer to ISO/IEC-13838-2 for detailed algorithm and working of MPEG-2 decoder.

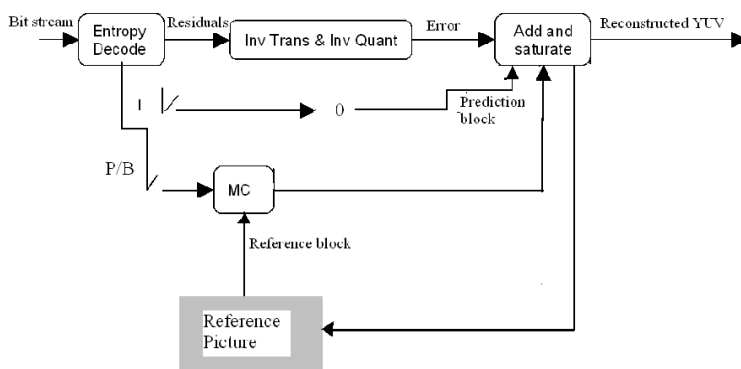

Figure 1-2. Flow Diagram of the MPEG2 Decoder

From this point onwards, all references to MPEG2 Decoder means MPEG2 Main Profile Decoder only.

1.3 Supported Services and Features

This user guide accompanies TI's implementation of MPEG2 Decoder on the HDVICP2 based platform.

This version of the codec has the following supported features:

- ❑ eXpressDSP Digital Media (XDM IVIDDEC3) compliant
- ❑ Uses hardware accelerators of HDVICP2
- ❑ Supports up to High level of Main Profile (MP)
- ❑ Supports decoding of MPEG-1 constrained video streams
- ❑ Supports progressive and interlaced type picture decoding
- ❑ Supports P and B frames
- ❑ Supports frame based decoding
- ❑ Supports picture width and height (resolutions) greater than 64 pixels including all standard resolutions up to 2048x2048
- ❑ Supports optional out-of-loop deblocking for display
- ❑ Supports graceful exit under error conditions
- ❑ Supports YUV420 semi-planar chroma format
- ❑ Independent of any Operating System
- ❑ Has logic and checks to help application to support trick mode playback
- ❑ Supports multi-channel functionality
- ❑ Supports dump of macroblock information (useful in transcode applications)
- ❑ Supports error concealment
- ❑ Supports debug trace dump

Installation Overview

This chapter provides a brief description on the system requirements and instructions for installing the codec component. It also provides information on building and running the sample test application.

Topic	Page
2.1 System Requirements	2-2
2.2 Installing the Component	2-3
2.3 Before Building the Sample Test Application	2-4
2.4 Building and Running the Sample Test Application	2-6
2.5 Configuration Files	2-8
2.6 Uninstalling the Component	2-10

2.1 System Requirements

This section describes the hardware and software requirements for the normal functioning of the codec component.

2.1.1 Hardware

This codec has been tested on the HDVICP2 and Media Controller based OMAP4 ES1.0 and DM816x DDR2 EVM REV-B hardware platforms.

2.1.2 Software

The following are the software requirements for the normal functioning of the codec:

- **Development Environment:** This project is developed using Code Composer Studio (Code Composer Studio v4) version 4.2.0.09000.
http://software-dl.ti.com/dsps/dsps_registered_sw/sdo_ccstudio/CCSv4/Prereleases/setup_CCS_4.2.0.09000.zip

- **Code Generation Tools:** This project is compiled, assembled, archived, and linked using the code generation tools version 4.5.1.

Although CG tools v 4.5.1 is a part of Code Composer Studio v4 installation, it is recommended that you re-install CG tools by downloading from the following link.

https://www-a.ti.com/downloads/sds_support/CodeGenerationTools.htm

And also install CG Tools version 5.0.3, this comes as a part of CCS installation. CG tools v5.0.3 are used in code compilation for Media Controller processor

- **HDVICP2 Simulator:** This codec has been tested using HDVICP2 Simulator version 5.0.16 (HDVICP2 Simulation CSP 1.1.5). This release can be obtained by software updates on Code Composer Studio v4. Ensure that the following site is listed as part of "Update sites to visit".

http://software-dl.ti.com/dsps/dsps_public_sw/sdo_ccstudio/CCSv4/Updates/IVAHD/site.xml

This codec has also been tested using Netra CSP (Simulation) version 0.7.1. This version of Simulator can be downloaded through software updates on Code Composer Studio v4. Ensure that the following site is listed as part of "Update sites to visit".

http://software-dl.ti.com/dsps/dsps_public_sw/sdo_ccstudio/CCSv4/Updates/NETRA/site.xml

2.2 Installing the Component

The codec component is released as a compressed archive. To install the codec, extract the contents of the zip file onto your local hard disk. The zip file extraction creates a top-level directory called 500.V.MPEG2.D.IVAHD.01.00 under which under which the directory named IVAHD_001 is created:

Figure 2-1 shows the sub-directories created in the IVAHD_001 directory.



Figure 2-1. Component Directory Structure

Table 2-1 provides a description of the sub-directories created in the 500.V.MPEG2.D.IVAHD.01.00 directory.

Sub-Directory	Description
\client\build\TestAppDeviceName	Contains the Media Controller cmd file. The name of this directory will not be same as exactly mentioned here. Instead of DeviceName string, actual name of Device will be present.
\client\build\TestAppDeviceName\make	Contains the make file for the test application project. The name of this directory will not be same as exactly mentioned here. Instead of DeviceName string, actual name of Device will be present.
\client\build\TestAppDeviceName\map	Contains the memory map generated on compilation of the code
\client\build\TestAppDeviceName\obj	Contains the intermediate .asm and/or .obj file generated on compilation of the code

Sub-Directory	Description
\client\build\TestAppDeviceName\Out	Contains the final application executable (.out) file generated by the sample test application
\client\test\inc	Contains header files needed for the application code
\client\test\src	Contains application C files
\client\test\testvecs\config	Contains sample configuration file for MPEG-2 Decoder
\client\test\testvecs\input	Contains input test vectors
\client\test\testvecs\output	Contains output generated by the codec. It is empty directory as part of release.
\client\test\testvecs\reference	Contains read-only reference output to be used for cross-checking against codec output
\docs	Contains user guide, data sheet
\inc	Contains interface header files of MPEG-2 Decoder
\lib	Contains jpegvdec_ti_host.lib – HDVICP2 MPEG-2 Decoder built as a library on Media Controller

Table 2-1. Component Directories

2.3 Before Building the Sample Test Application

This codec is accompanied by a sample test application. To run the sample test application, you need TI Framework Components (FC).

This version of the codec has been validated with Framework Components (FC) version 3.20.00.22 GA.

To run the Simulator version of the codec, the HDVICP2 simulator has to be installed. The version of the simulator is 5.0.16. This can be done using the “Help->Software Updates->Find and Install” option in CCSv4. Detailed instructions to set up the configuration can be found in `ivahd_sim_user_guide.pdf` present in `<CCSv4 Installation Dir>\simulation_csp_omap4\docs\pdf\` directory.

This codec has also been validated on Netra Video Processing Simulator that simulates all the three HDVICP2s in DM816x. The simulator required for this is Netra CSP (Simulation) version 0.7.1. This simulator can also be installed using the “Help->Software Updates->Find and Install” option in CCSv4. Detailed instructions to set up the configuration can be found in `netra_sim_user_guide.pdf` present in `<CCSv4 Installation Dir>\simulation_netra\docs\user_guide` directory.

Install CG Tools version 4.5.1 for ARM (TMS470) at the following location in your system: `<CCSv4.2_InstallFolder>\ccsv4\tools\compiler\tms470`.

CGTools 4.5.1 can be downloaded from

https://www-a.ti.com/downloads/sds_support/CodeGenerationTools.htm

Please note that CG Tools 4.5.1 is installed at the location mentioned above along with the CCS v4.2 installation by default. But, as some problems have been reported about this, we recommend that you install CG Tools 4.5.1 again with the installer obtained from the above link.

And also install CG Tools version 5.0.3, this comes as a part of CCS installation. CG tools v5.0.3 are used in code compilation for Media Controller processor.

Set environment variable CG_TOOL_DIR to <cgtools_install_dir>.

<CG_TOOL_DIR>/bin should contain all required code generation tools executables.

Set environment variable CG_TOOL_DIR_M3 pointing to <cg_tools v5.0.3>

<CG_TOOL_DIR_M3>/bin should contain all required code generation tools executables.

Set environment variables HDVICP2_INSTALL_DIR and CSP_INSTALL_DIR to the locations where the HDVICP20 API library and HDVICP2 CSL are present. The HDVICP20 API library and the HDVICP2 CSL can be downloaded from the same place as the codec package. The HDVICP20 API .lib files should be present at HDVICP2_INSTALL_DIR/lib and HDVICP20 API interface header files at HDVICP2_INSTALL_DIR/inc. The folders csl_ivahd and csl_soc of HDVICP2 CSL should be present at CSP_INSTALL_DIR/.

This version of the codec has been validated with HDVICP2.0 API library version 01.00.00.23 and HDVICP2.0 CSL Version 00.05.02.

Set the system environment variable TI_DIR to the CCSv4 installation path. Example: TI_DIR = <CCSv4 Installation Dir>\ccsv4.

Add gmake (GNU Make version 3.78.1) utility folder path (for example, "C:\CCStudioV4.0\ccsv4\utils\gmake") at the beginning of the PATH environment variable.

The version of the XDC tools required is 3.20.04.68 GA.

2.3.1 Installing Framework Component (FC)

You can download FC from the TI website:

http://software-dl.ti.com/dsp/dsp_public_sw/sdo_sb/targetcontent/fc/3_20_00_22/index_FDS.html

Extract the FC zip file to the some location and set the system environment variable FC_INSTALL_DIR to this path. For example: if the zip file was extracted to C:\CCSv4\, set FC_INSTALL_DIR as C:\CCSv4\framework_components_3_20_00_22.

The test application uses the following IRES and XDM files:

- HDVICP related IRES header files, these are available in the FC_INSTALL_DIR\packages\ti\sdofc\ires\hdvicip directory.
- Tiled memory related Header file, these are available in the FC_INSTALL_DIR\fctools\packages\ti\sdofc\ires\tiledmemory directory.
- XDM related header files, these are available in the FC_INSTALL_DIR\fctools\packages\ti\xdais directory

2.3.2 Installing XDC Tools

XDC Tools is required to build the test application. The test application uses the standard files like <std.h> from XDC tools. The xdc tools can be downloaded and installed from the following URL:

http://software-dl.ti.com/dsps/dsps_public_sw/sdo_sb/targetcontent/rtsc/3_20_04_68/index_FDS.html

Also, ensure that the environment variable XDCROOT is set to the XDC installation directory.

2.4 Building and Running the Sample Test Application

2.4.1 Building the Sample Test Application

MPEG-2 decoder on HDVICP2 and Media Controller based platform has the following projects.

Project	Make file Path	Output files
Test Application	\client\build\ <testappdevicename>\make\< td=""> <td>\client\build\TestApp<DeviceName>\out \mpeg2vdec_ti_hosttestapp.out</td> </testappdevicename>\make\<>	\client\build\TestApp<DeviceName>\out \mpeg2vdec_ti_hosttestapp.out

The make file for the project can be built using the following commands.

```
gmake -k -s deps
```

```
gmake -k -s all
```

Use the following command to clean previous builds.

```
gmake -k -s clean
```

2.4.2 Running the Sample Test Application on Netra HDVICP2 Simulator

The sample test application that accompanies this codec component will run in TI's Code Composer Studio development environment. To run the sample test application on HDVICP2 Simulator, follow these steps:

- 1) Ensure that you have installed IVAHD CSP (Simulation) version 1.1.5.
- 2) Start Code Composer Studio v4 and set up the target configuration for Netra IVA-HD Simulator.

- 3) Select the Debug perspective in the workbench. Launch Netra IVA-HD simulator in CCSv4 (**View > Target Configurations > %Netra Simulator%**).
- 4) Select M3_Video device and **Target > Load Program**, browse to the \500.V.MPEG2.D.IVAHD.01.00\IVAHD_001\client\build\TestAppDeviceName\out\ sub-directory, select the codec executable “mpeg2vdec_ti_hosttestapp.out” and load it into Code Composer Studio in preparation for execution.
- 5) Select HDVICP2_0_ICONT1 device and **Target > Run** to give iCont1 device a free run.
- 6) Select HDVICP2_0_ICONT2 device and **Target > Run** to give iCont2 device a free run.
- 7) Select **Target > Run** to execute the application for M3_Video device.
- 8) Test application will take input streams from \500.V.MPEG2.D.IVAHD.01.00\IVAHD_001\client\test\testvecs\input\ directory and generates outputs in \500.V.MPEG2.D.IVAHD.01.00\IVAHD_001\client\test\testvecs\output\ directory.

2.4.3 Running the Sample Test Application on DM816x EVM

The sample test application that accompanies this codec component will run in TI's Code Composer Studio development environment. To run the sample test application on DM816x EVM, follow these steps:

- 1) Start Code Composer Studio v4 and set up the target configuration for DM816x EVM Emulator.
- 2) Ensure that the clock is enabled for Media Controller and HDVICP2.
- 3) Select the Debug perspective in the workbench. Launch DM816x EVM Emulator in CCSv4 (**View > Target Configurations > %DM816x EVM%**).
- 4) Select Cortex_M3_RTOS_0 device, right click and choose “Connect Target” and wait for emulator to connect to Media Controller
- 5) Select Cortex_M3_RTOS_0 device and **Target > Load Program**, browse to \500.V.MPEG2.D.IVAHD.01.00\IVAHD_001\client\build\TestAppDM816x\out\ sub-directory, select the codec executable “mpeg2vdec_ti_hosttestapp.out” and load it in preparation for execution.
- 6) Select **Target > Run** to execute the application for Cortex_M3_RTOS_0 device.
- 7) Test application will take input streams from \500.V.MPEG2.D.IVAHD.01.00\IVAHD_001\client\test\testvecs\input\ directory and generates outputs in \500.V.MPEG2.D.IVAHD.01.00\IVAHD_001\client\test\testvecs\output\ directory.

Note:

Order of connecting to the devices is important and it should be as mentioned in above steps.

2.5 Configuration Files

This codec is shipped along with:

- ❑ Generic configuration file (Testvecs.cfg) – specifies input and reference files for the sample test application.
- ❑ Decoder configuration file (Testparams.cfg) – specifies the configuration parameters used by the test application to configure the Decoder.

2.5.1 Generic Configuration File

The sample test application shipped along with the codec uses the configuration file, Testvecs.cfg for determining the input and reference files for running the codec and checking for compliance. The Testvecs.cfg file is available in the \Client\Test\TestVecs\Config sub-directory.

The format of the Testvecs.cfg file is:

```
X
Config
Input
Output or Reference
SizeFile
```

where:

- ❑ `X` may be set as:
 - 1 - for compliance checking.
 - 0 - for writing the output to the output file
- ❑ `Config` is the Decoder configuration file. For details, see Section 2.5.2
- ❑ `Input` is the input file name (use complete path).
- ❑ `Output` is the output .yuv file name (output dump mode). `Reference` is the reference .yuv file name (in compliance checking mode).
- ❑ `SizeFile` is the file containing offsets and size of each frame for TST_FRAME_MODE.

A sample Testvecs.cfg file is as shown:

```
0
..\..\Test\TestVecs\Config\Testparams.cfg
..\..\Test\TestVecs\Input\davincieffect_qcif_25fps.mp2
..\..\Test\TestVecs\Output\davincieffect_qcif_25fps.yuv
..\..\Test\TestVecs\Config\sizeFile.cfg
```

In compliance mode of operation, the decoder compares the reference and the generated output and declares Pass/Fail message. If output dump mode is selected(X set to 0), then the decoder dumps the output to the specified file.

A sample SizeFile is as shown:

```
/* The first field gives offset from
start of input file for each frame */

/* The second field gives frame size
+3, i.e size including the start code
of next picture */

0      4840

4837  4475

9309  978

10284 958

11239 6147

/* To indicate no more input frames */

0      0
```

Note that an additional 3 bytes should be added to the frame size (to include the next start code).

2.5.2 Decoder Configuration File

The decoder configuration file, Testparams.cfg contains the configuration parameters required for the decoder. The Testparams.cfg file is available in the \Client\Test\TestVecs\Config sub-directory.

A sample Testparams.cfg file is as shown:

```
# New Input File Format is as follows
# <ParameterName> = <ParameterValue> # Comment

#####
# Parameters
#####
ImageWidth      = 2048    # Image width in Pels
ImageHeight     = 2048    # Image height in Pels
ChromaFormat    = 9      # 256 =>XDM_YUV_420SP
FramesToDecode  = 100    # Number of frames to be coded
DumpFrom        = 0      # Start dumping from this frame
```

Note:

ChromaFormat supported in this codec is 420 semi-planar, that is, the chroma planes (Cb and Cr) are interleaved.

2.6 Uninstalling the Component

To uninstall the component, delete the codec directory from your hard disk.

This page is intentionally left blank

Sample Usage

This chapter provides a detailed description of the sample test application that accompanies this codec component.

Topic	Page
3.1 Overview of the Test Application	3-2
3.2 Frame Buffer Management by Application	3-6
3.3 Handshaking Between Application and Algorithm	3-8
3.4 Address Translations	3-10
3.5 Sample Test Application	3-10

3.1 Overview of the Test Application

The test application exercises the `IVIDDEC3` base class of the MPEG2 Decoder library. The main test application files are `mpeg2vdec_ti_hosttestapp.c` and `mpeg2vdec_ti_rmanConfig.c`. These files are available in the `\dec\mpeg2\client\test\src` directory.

Figure 3-1 depicts the sequence of APIs exercised in the sample test application. Currently, the test application does not use RMAN resource manager. However, all the resource allocations happens through IRES interfaces.

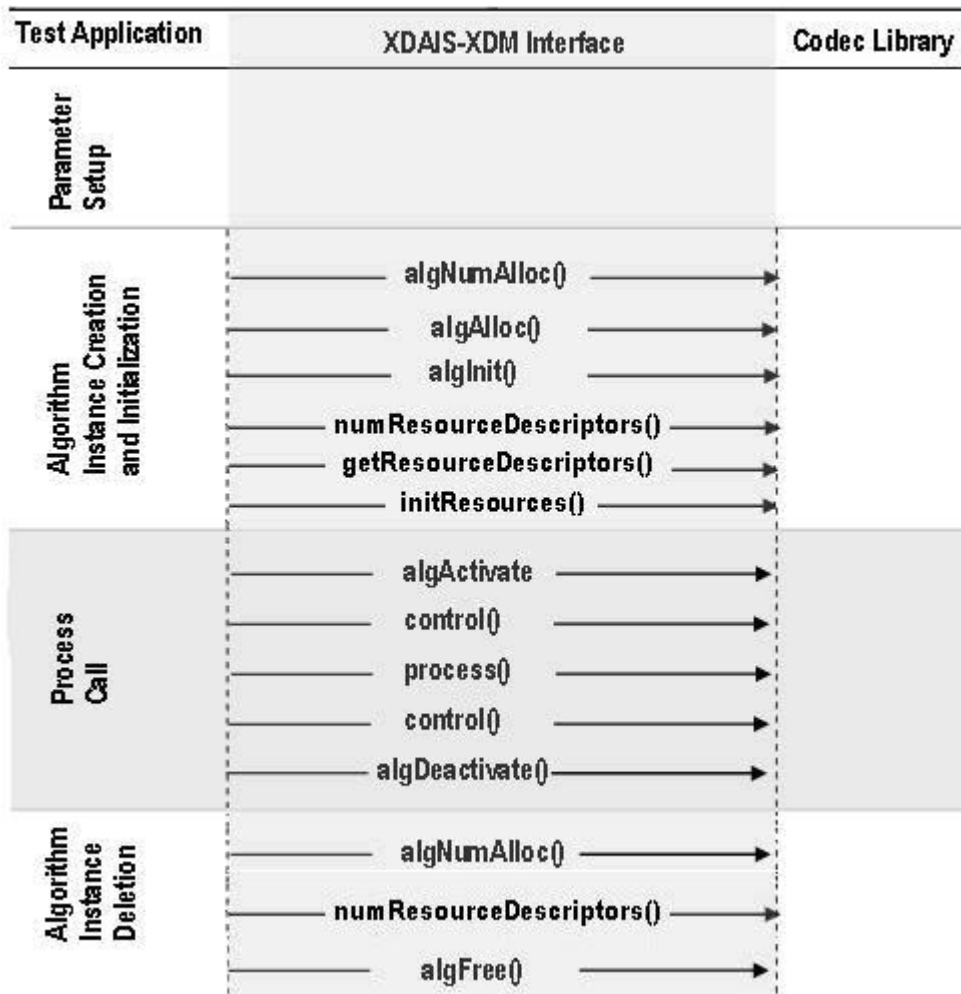

Figure 3-1. Test Application Sample Implementation

The test application is divided into four logical blocks:

- ❑ Parameter setup
- ❑ Algorithm instance creation and initialization
- ❑ Process call
- ❑ Algorithm instance deletion

3.1.1 *Parameter Setup*

Each codec component requires various codec configuration parameters to be set at initialization. For example, a video codec requires parameters such as video height, video width, and so on. The test application obtains the required parameters from the Decoder configuration files.

In this logical block, the test application does the following:

Opens the generic configuration file, `Testvecs.cfg` and reads the compliance checking parameter, Decoder configuration file name (`Testparams.cfg`), input file name, and output/reference file name.

Opens the Decoder configuration file, (`Testparams.cfg`) and reads the various configuration parameters required for the algorithm. For more details on the configuration files, see Section 0.

Sets the `IVIDDEC3_Params` structure based on the values it reads from the `Testparams.cfg` file.

Reads the input bit-stream into the application input buffer.

After successful completion of these steps, the test application does the algorithm instance creation and initialization.

3.1.2 *Algorithm Instance Creation and Initialization*

In this logical block, the test application accepts the various initialization parameters and returns an algorithm instance pointer. The following APIs are called in sequence:

`algNumAlloc()` - To query the algorithm about the number of memory records it requires.

`algAlloc()` - To query the algorithm about the memory requirement to be filled in the memory records.

`algInit()` - To initialize the algorithm with the memory structures provided by the application.

A sample implementation of the create function that calls `algNumAlloc()`, `algAlloc()`, and `algInit()` in sequence is provided in the `ALG_create()` function implemented in the `alg_create.c` file.

Note:

- ❑ Decoder requests only one memory buffer through `algNumAlloc`. This buffer is for the algorithm handle.
- ❑ Other memory buffer requirements are done through IRES interfaces.

After successful creation of the algorithm instance, the test application does HDVICP Resource and memory buffer allocation for the algorithm. Currently, RMAN resource manager is not used. However, all the resource allocations happen through IRES interfaces:

`numResourceDescriptors()` - To understand the number of resources (HDVICP and buffers) needed by algorithm.

`getResourceDescriptors()` – To get the attributes of the resources.

`initResources()` - After resources are created, application gives the resources to algorithm through this API.

3.1.3 Process Call

After algorithm instance creation and initialization, the test application does the following:

Sets the dynamic parameters (if they change during run-time) by calling the `control()` function with the `XDM_SETPARAMS` command.

Sets the input and output buffer descriptors required for the `process()` function call. The input and output buffer descriptors are obtained by calling the `control()` function with the `XDM_GETBUFINFO` command.

Implements the process call based on the non-blocking mode of operation explained in step 4. The behavior of the algorithm can be controlled using various dynamic parameters (see Section 4.2.1.8). The inputs to the `process()` functions are input and output buffer descriptors, pointer to the `IVIDDEC3_InArgs` and `IVIDDEC3_OutArgs` structures.

On the call to the `process()` function for encoding/decoding a single frame of data, the software triggers the start of encode/decode. After triggering the start of the encode/decode frame, the video task can be put to `SEM-pend` state using semaphores. On receipt of interrupt signal at the end of frame encode/decode, the application releases the semaphore and resume the video task, which does any book-keeping operations by the codec and updates the output parameter of `IVIDDEC3_OutArgs` structure.

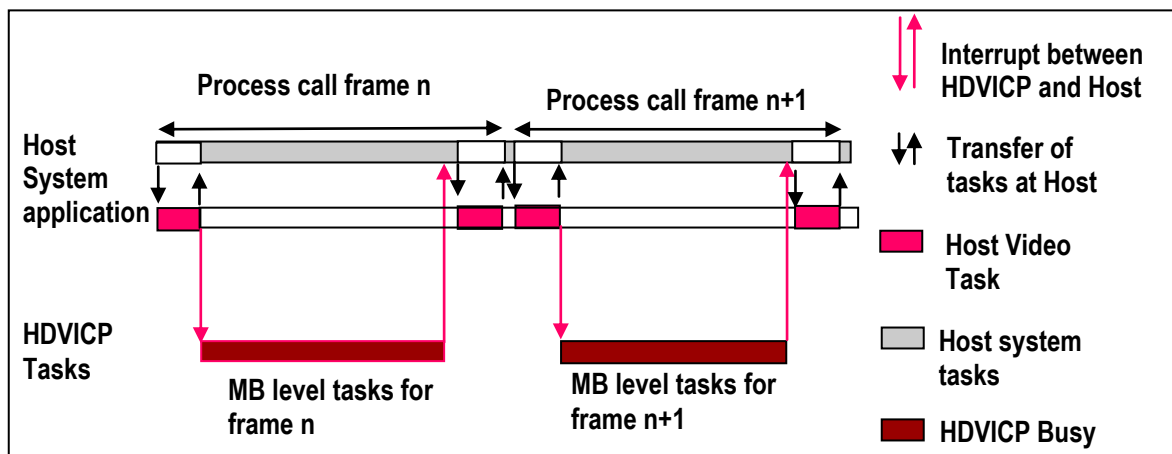

Figure 3-2. Process call with Host release

The `control()` and `process()` functions should be called only within the scope of the `algActivate()` and `algDeactivate()` XDAIS functions which activate and deactivate the algorithm instance respectively. Once an algorithm is activated, there could be any ordering of `control()` and `process()` functions. The following APIs are called in a sequence:

`algActivate()` - To activate the algorithm instance.

`control()` (optional) - To query the algorithm on status or setting of dynamic parameters and so on, using the six available control commands.

`process()` - To call the Decoder with appropriate input/output buffer and arguments information.

`control()` (optional) - To query the algorithm on status or setting of dynamic parameters and so on, using the six available control commands.

`algDeactivate()` - To deactivate the algorithm instance.

The do-while loop encapsulates picture level `process()` call and updates the input buffer pointer every time before the next call. The do-while loop breaks off either when an error condition occurs or when the input buffer exhausts. It also protects the `process()` call from file operations by placing appropriate calls for cache operations. The test application does a cache invalidate for the valid input buffers before `process()` and a cache write back invalidate for output buffers after a `control()` call with `GET_STATUS` command.

In the sample test application, after calling `algDeactivate()`, the output data is either dumped to a file or compared with a reference file.

3.1.4 Algorithm Instance Deletion

Once decoding/encoding is complete, the test application frees the memory resources and deletes the current algorithm instance. The following APIs are called in sequence:

`numResourceDescriptors()` - To get the number of resources and free them. If the application needs handles to the resources, it can call `getResourceDescriptors()`.

`algNumAlloc()` - To query the algorithm about the number of memory records it used.

`algFree()` - To query the algorithm for memory, to free when removing an instance.

A sample implementation of the delete function that calls `algNumAlloc()` and `algFree()` in sequence is provided in the `ALG_delete()` function implemented in the `alg_create.c` file.

3.2 Frame Buffer Management by Application

3.2.1 Frame Buffer Input and Output

With the new XDM, decoder does not ask for frame buffer at the time of `alg_create()`. It uses buffer from `XDM2_BufDesc *outBufs`, which it reads during each decode process call. Hence, there is no distinction between DPB and display buffers. The framework needs to ensure that it does not overwrite the buffers that are locked by the codec.

```
mp2VDEC_create();
mp2VDEC_control(XDM_GETBUFINFO); /* Returns default 1080p
HD size */
do{
mp2VDEC_decode(); //call the decode API
mp2VDEC_control(XDM_GETBUFINFO); /* updates the memory
required as per the size parsed in stream header */
}
while(all frames)
```

- ❑ Note:
- ❑ Application can take the information returned by the control function with the `XDM_GETBUFINFO` command and change the size of the buffer passed in the next process call.
- ❑ The output luma buffer size required is :
 $((\text{width aligned to multiple of } 16 + 2) * (\text{height aligned to multiple of } 16 + 2))$.
 For chroma buffer, the height need to be halved. This assumes worst case padding requirement, That is, for interlaced coding. For the first `GETBUFINFO` call, `maxheight` and `maxwidth` are used for calculating buffer size. For subsequent `GETBUFINFO` calls (That is, after the first process call, when the decoder gets to know the

actual height and width from the headers) the actual height and width are used. Hence, this can be optionally used by the application to re-allocate the buffer sizes, if required.

- ❑ Application can re-use the extra buffer space of the 1st frame, if the above control call returns a small size than that was provided.

The frame pointer given by the application and that returned by the algorithm may be different. `BufferID (InputID/outputID)` provides the unique ID to keep a record of the buffer given to the algorithm and released by the algorithm.

As explained above, buffer pointer cannot be used as a unique identifier to keep a record of frame buffers. Any buffer given to algorithm should be considered locked by algorithm, unless the buffer is returned to the application through `IVIDDEC3_OutArgs->freeBufID[]`.

- ❑ Note:
- ❑ `BufferID` returned in `IVIDDEC3_OutArgs ->outputID[]` is only for display purpose. Application should not consider it free unless it is a part of `IVIDDEC3_OutArgs->freeBufID[]`.

3.2.2 Frame Buffer Format

The frame buffer format to be used for both progressive and interlaced pictures is as explained in Chapter 6 of this document.

3.2.3 Frame Buffer Management by Application

The application framework can efficiently manage frame buffers by keeping a pool of free frames from which it gives the decoder empty frames on request.

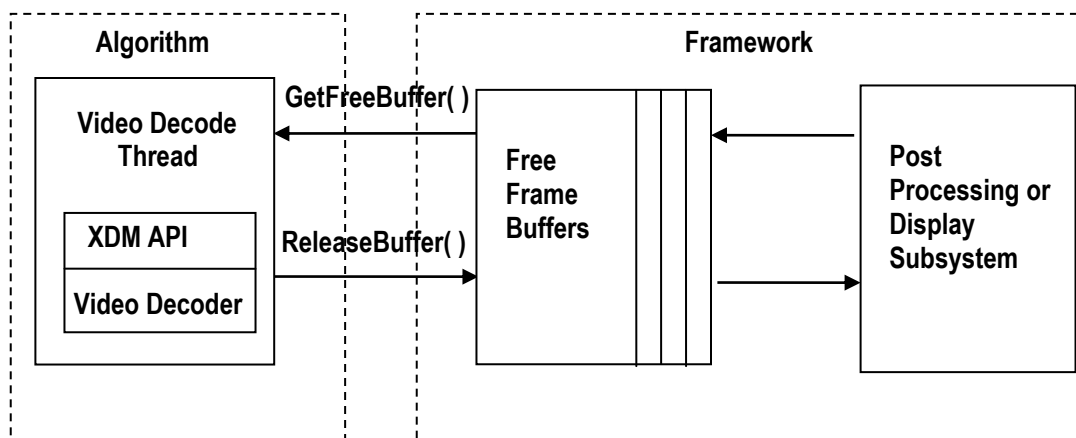

Figure 3-3. Interaction of Frame Buffers Between Application and Framework

The sample application also provides a prototype for managing frame buffers. It implements the following functions, which are defined in file `buffermanager.c` provided along with test application.

- ❑ `BUFFMGR_Init()` - `BUFFMGR_Init` function is called by the test application to initialize the global buffer element array to default and to allocate the required number of memory data for reference and output buffers. The maximum required DPB size is defined by the supported profile and level.
- ❑ `BUFFMGR_ReInit()` - `BUFFMGR_ReInit` function allocates global luma and chroma buffers and allocates entire space to the first element. This element will be used in the first frame decode. After the picture height and width and its luma and chroma buffer requirements are obtained, the global luma and chroma buffers are re-initialized to other elements in the buffer array.
- ❑ `BUFFMGR_GetFreeBuffer()` - `BUFFMGR_GetFreeBuffer` function searches for a free buffer in the global buffer array and returns the address of that element. In case none of the elements are free, then it returns `NULL`.
- ❑ `BUFFMGR_ReleaseBuffer()` - `BUFFMGR_ReleaseBuffer` function takes an array of buffer-IDs which are released by the test application. 0 is not a valid buffer ID, hence this function moves until it encounters a buffer ID as zero or it hits the `MAX_BUFF_ELEMENTS`.
- ❑ `BUFFMGR_DeInit()` - `BUFFMGR_DeInit` function releases all memory allocated by buffer manager.

3.3 Handshaking Between Application and Algorithm

Application provides the algorithm with its implementation of functions for the video task to move to `SEM-pend` state, when the execution happens in the co-processor. The algorithm calls these application functions to move the video task to `SEM-pend` state.

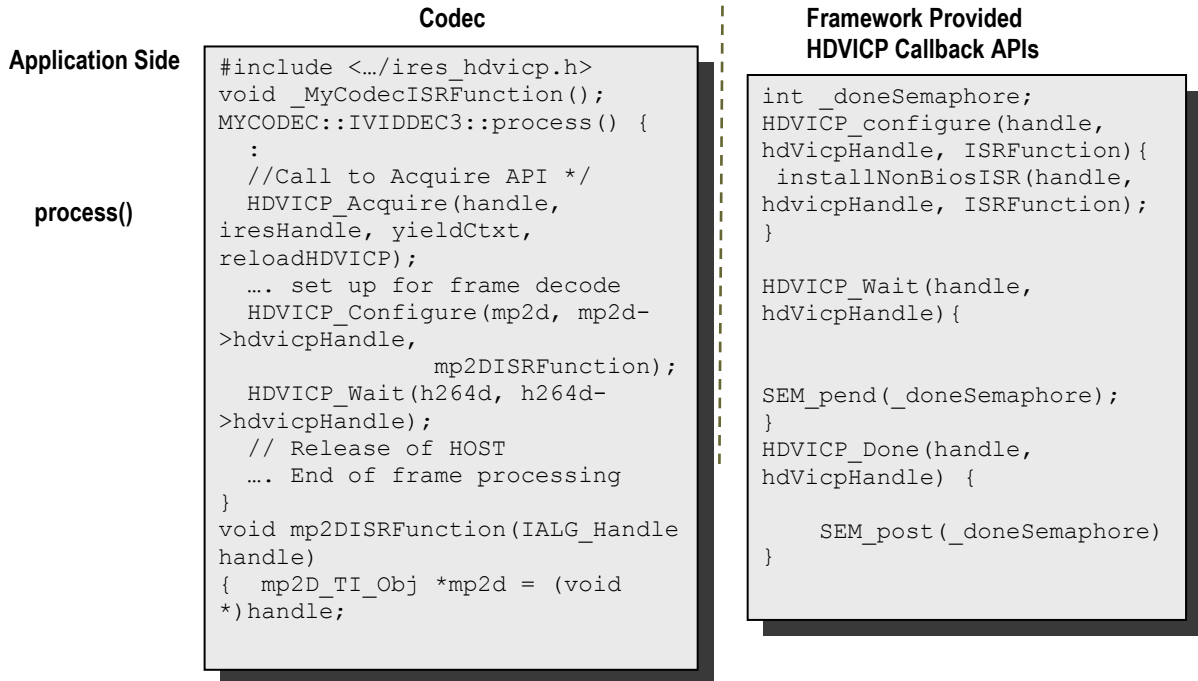

Figure 3-4. Interaction Between Application and Codec

- ❑ Note:
- ❑ Process call architecture to share Host resource among multiple threads.
- ❑ ISR ownership is with the Host layer resource manager – outside the codec.
- ❑ The actual codec routine to be executed during ISR is provided by the codec.
- ❑ OS/System related calls (SEM_pend, SEM_post) also outside the codec.
- ❑ Codec implementation is OS independent.

The functions to be implemented by the application are:

- ❑ void HDVICP_Acquire(IALG_Handle handle, IRES_HDVICP2_Handle iresHandle, IRES_YieldContext *yieldCtxt, Bool *reloadHDVICP)

This function is called by the algorithm to acquire the HDVICP2 resource.

- ❑ HDVICP_Configure(IALG_Handle handle, IRES_HDVICP2_Handle iresHandle, void(*IRES_HDVICP2_CallbackFxn)(IALG_Handle handle, void *cbArgs), void *cbArgs)

This function is called by the algorithm to register its ISR function, which the application needs to call when it receives interrupts pertaining to the video task.

- ❑ HDVICP_Wait (void *hdvicpHandle)

This function is called by the algorithm to move the video task to SEM-pend state.

- ❑ HDVICP_Done (void *hdvicpHandle)

This function is called by the algorithm to release the video task from SEM-pend state. In the sample test application, these functions are implemented in `hdvicp_framework.c` file. The application can implement it in a way considering the underlying system.

3.4 Address Translations

The buffers addresses(DDR addresses) as seen by Media Controller and HDVICP2(VDMA) will be different. Hence, address translations are needed to convert from one address view to another. The application needs to implement a MEMUTILS function for this address translation (which will be later implemented by the framework components). An example of the address translation function is as shown. The codec will make a call to this function from the host (Media Controller) library. Therefore, the function name and arguments should follow the example provided below. For a given input address, this function returns the VDMA view of the buffer (that is, address as seen by HDVICP2).

```
void *MEMUTILS_getPhysicalAddr(Ptr Addr)
{
    return ((void *) ((unsigned int)Addr & VDMAVIEW_EXTMEM));
}
```

Sample settings for the macro `VDMAVIEW_EXTMEM` is as shown.

```
#if defined(HOSTARM968_FPGA)
    #define VDMAVIEW_EXTMEM (0x07FFFFFF)
#elif defined(HOSTCORTEXMEDIA_CONTROLLER_OMAP4)
    #define VDMAVIEW_EXTMEM (0xFFFFFFFF)
#else
    #define VDMAVIEW_EXTMEM (0x07FFFFFF)
#endif
```

3.5 Sample Test Application

The test application exercises the `IVIDDEC3` base class of the MPEG-2 Decoder.

```
/*Main Function acting as a client for Video Decode Call*/
    BUFFMGR_Init();

    TestApp_SetInitParams(&params.viddecParams);

    /*----- Decoder creation -----*/
    handle = (IALG_Handle) mp2VDEC_create();
```

```

/* Get Buffer information */
MPEG2VDEC_TI_control(handle, XDM_GETBUFINFO);

/* Do-While Loop for Decode Call for a given stream */
do
{
/* Read the bitstream in the Application Input Buffer */
validBytes = TestApp_ReadByteStream(inFile);

/* Get free buffer from buffer pool */
buffEle = BUFFMGR_GetFreeBuffer();
/* Optional: Set Run-time parameters in the Algorithm via
control() */

MPEG2VDEC_TI_control(handle, XDM_SETPARAMS);

/*-----*/
/* Start the process : To start decoding a frame */
/*-----*/
retVal = MPEG2VDEC_TI_decode
(
handle,
(XDM1_BufDesc *)&inputBufDesc,
(XDM_BufDesc *)&outputBufDesc,
(IVIDDEC3_InArgs *)&inArgs,
(IVIDDEC3_OutArgs *)&outArgs
);

/* Get the statatus of the decoder using control */
MPEG2VDEC_TI_control(handle, IMPEG2VDEC_GETSTATUS);

/* Get Buffer information */
MPEG2VDEC_TI_control(handle, XDM_GETBUFINFO);

/* Optional: Reinit the buffer manager in case the
/* frame size is different */
BUFFMGR_ReInit();

/* Always release buffers - which are released from
/* the algorithm side -back to the buffer manager
*/
BUFFMGR_ReleaseBuffer((XDAS_UInt32
*)outArgs.freeBufID);

} while(1);
/* end of Do-While loop - which decodes frames */

ALG_delete (handle);

BUFFMGR_DeInit();

```

- ❑ Note:
- ❑ This sample test application does not depict the actual function parameter or control code. It shows the basic flow of the code.

API Reference

This chapter provides a detailed description of the data structures and interfaces functions used in the codec component.

Topic	Page
4.1 Symbolic Constants and Enumerated Data Types	4-2
4.2 Data Structures	4-25
4.3 Interface Functions	4-43

4.1 Symbolic Constants and Enumerated Data Types

This section describes the XDM defined data structures that are common across codec classes. These XDM data structures can be extended to define any implementation specific parameters for a codec component.

Table 4-1. List of Enumerated Data Types

Group or Enumeration Class	Symbolic Constant Name	Description or Evaluation
IVIDEO_FrameType	IVIDEO_NA_FRAME	Frame type not available
	IVIDEO_I_FRAME	Intra coded frame
	IVIDEO_P_FRAME	Forward inter coded frame
	IVIDEO_B_FRAME	Bi-directional inter coded frame
	IVIDEO_IDR_FRAME	Intra coded frame that can be used for refreshing video content. Not supported in this version of MPEG2 Decoder.
	IVIDEO_II_FRAME	Interlaced Frame, both fields are I frames
	IVIDEO_IP_FRAME	Interlaced Frame, first field is an I frame, second field is a P frame
	IVIDEO_IB_FRAME	Interlaced Frame, first field is an I frame, second field is a B frame. Not supported in this version of MPEG2 Decoder.
	IVIDEO_PI_FRAME	Interlaced Frame, first field is a P frame, second field is a I frame. Not supported in this version of MPEG2 Decoder.
	IVIDEO_PP_FRAME	Interlaced Frame, both fields are P frames
	IVIDEO_PB_FRAME	Interlaced Frame, first field is a P frame, second field is a B frame. Not supported in this version of MPEG2 Decoder.
	IVIDEO_BI_FRAME	Interlaced Frame, first field is a B frame, second field is an I frame. Not supported in this version of MPEG2 Decoder.
IVIDEO_BP_FRAME	Interlaced Frame, first field is a B frame, second field is a P frame. Not supported in this version of MPEG2 Decoder.	

Group or Enumeration Class	Symbolic Constant Name	Description or Evaluation
	IVIDEO_BB_FRAME	Interlaced Frame, both fields are B frames. Not supported in this version of MPEG2 Decoder.
	IVIDEO_MBAFF_I_FRAME	Intra coded MBAFF frame. Not supported in this version of MPEG2 Decoder.
	IVIDEO_MBAFF_P_FRAME	Forward inter coded MBAFF frame. Not supported in this version of MPEG2 Decoder.
	IVIDEO_MBAFF_B_FRAME	Bi-directional inter coded MBAFF frame. Not supported in this version of MPEG2 Decoder.
	IVIDEO_MBAFF_IDR_FRAME	Intra coded MBAFF frame that can be used for refreshing video content. Not supported in this version of MPEG2 Decoder.
	IVIDEO_FRAMETYPE_DEFAULT	Default set to IVIDEO_I_FRAME
IVIDEO_ContentType	IVIDEO_CONTENTTYPE_NA	Content type is not applicable
	IVIDEO_PROGRESSIVE IVIDEO_PROGRESSIVE_FRAME	Progressive video content
	IVIDEO_INTERLACED IVIDEO_INTERLACED_FRAME	Interlaced video content
	IVIDEO_INTERLACED_TOPFIELD	Interlaced video content, Top field
	IVIDEO_INTERLACED_BOTTOMFIELD	Interlaced video content, Bottom field
	IVIDEO_CONTENTTYPE_DEFAULT	Default set to IVIDEO_PROGRESSIVE
IVIDEO_FrameSkip	IVIDEO_NO_SKIP	Do not skip the current frame. Default Value.
	IVIDEO_SKIP_P	Skip forward inter coded frame. Not supported in this version of MPEG2 Decoder.
	IVIDEO_SKIP_B	Skip bi-directional inter coded frame.
	IVIDEO_SKIP_I	Skip intra coded frame. Not supported in this version of MPEG2 Decoder.

Group or Enumeration Class	Symbolic Constant Name	Description or Evaluation
	IVIDEO_SKIP_IP	Skip I and P frame/field(s). Not supported in this version of MPEG2 Decoder.
	IVIDEO_SKIP_IB	Skip I and B frame/field(s). Not supported in this version of MPEG2 Decoder.
	IVIDEO_SKIP_PB	Skip P and B frame/field(s). Not supported in this version of MPEG2 Decoder.
	IVIDEO_SKIP_IPB	Skip I/P/B/BI frames Not supported in this version of MPEG2 Decoder.
	IVIDEO_SKIP_IDR	Skip IDR Frame Not supported in this version of MPEG2 Decoder.
	IVIDEO_SKIP_NONREFERENC E	Skip non reference frame.
	IVIDEO_SKIP_DEFAULT	Default set to IVIDEO_NO_SKIP
IVIDEO_VideoLayout	IVIDEO_FIELD_INTERLEAVE D	Buffer layout is interleaved.
	IVIDEO_FIELD_SEPARATED	Buffer layout is field separated.
	IVIDEO_TOP_ONLY	Buffer contains only top field.
	IVIDEO_BOTTOM_ONLY	Buffer contains only bottom field
IVIDEO_OperatingMode	IVIDEO_DECODE_ONLY	Decoding Mode
	IVIDEO_ENCODE_ONLY	Encoding Mode. Not applicable for decoder.
	IVIDEO_TRANSCODE_FRAMEL EVEL	Transcode Mode of operation (encode/decode), which consumes /generates transcode information at the frame level.
	IVIDEO_TRANSCODE_MBLEVE L	Transcode Mode of operation (encode/decode), which consumes /generates transcode information at the MB level. Not supported in this version of decoder.
	IVIDEO_TRANSRATE_FRAMEL EVEL	Transrate Mode of operation for encoder, which consumes transrate information at the frame level. Not supported in this version of decoder.

Group or Enumeration Class	Symbolic Constant Name	Description or Evaluation
	IVIDEO_TRANSRATE_MBLEVEL	Transrate Mode of operation for encoder, which consumes transrate information at the MB level. Not supported in this version of decoder.
IVIDEO_OutputFrameStatus	IVIDEO_FRAME_NOERROR	Output buffer is available.
	IVIDEO_FRAME_NOTAVAILABLE	Codec does not have any output buffers.
	IVIDEO_FRAME_ERROR	Output buffer is available and corrupted.
	IVIDEO_FRAME_OUTPUTSKIP	The video frame was skipped (that is not decoded)
	IVIDEO_OUTPUTFRAMESTATUS_DEFAULT	Default set to IVIDEO_FRAME_NOERROR
IVIDEO_PictureType	IVIDEO_NA_PICTURE	Frame type not available
	IVIDEO_I_PICTURE	Intra coded picture
	IVIDEO_P_PICTURE	Forward inter coded picture
	IVIDEO_B_PICTURE	Bi-directional inter coded picture
IVIDEO_DataMode	IVIDEO_FIXEDLENGTH	Input to the decoder is in multiples of a fixed length (example, 4K) (input side for decoder). Not supported in this version of MPEG2 Decoder.
	IVIDEO_SLICEMODE	Slice mode of operation (Input side for decoder). Not supported in this version of MPEG2 Decoder.
	IVIDEO_NUMROWS	Number of rows, each row is 16 lines of video (output side for decoder). Not supported in this version of MPEG2 Decoder.
	IVIDEO_ENTIREFRAME	Processing of entire frame data
IVIDDEC3_displayDelay	IVIDDEC3_DISPLAY_DELAY_AUTO	Decoder decides the display delay. Not supported in this version of MPEG2 Decoder.
	IVIDDEC3_DECODE_ORDER	Display frames are in decoded order without delay
	IVIDDEC3_DISPLAY_DELAY_1	Display the frames with 1 frame delay

Group or Enumeration Class	Symbolic Constant Name	Description or Evaluation
	IVIDDEC3_DISPLAY_DELAY_2	Display the frames with 2 frame delay. Not supported in this version of MPEG2 Decoder.
	IVIDDEC3_DISPLAY_DELAY_3	Display the frames with 3 frame delay. Not supported in this version of MPEG2 Decoder.
	IVIDDEC3_DISPLAY_DELAY_4	Display the frames with 4 frame delay. Not supported in this version of MPEG2 Decoder.
	IVIDDEC3_DISPLAY_DELAY_5	Display the frames with 5 frame delay. Not supported in this version of MPEG2 Decoder.
	IVIDDEC3_DISPLAY_DELAY_6	Display the frames with 6 frame delay. Not supported in this version of MPEG2 Decoder.
	IVIDDEC3_DISPLAY_DELAY_7	Display the frames with 7 frame delay. Not supported in this version of MPEG2 Decoder.
	IVIDDEC3_DISPLAY_DELAY_8	Display the frames with 8 frame delay. Not supported in this version of MPEG2 Decoder.
	IVIDDEC3_DISPLAY_DELAY_9	Display the frames with 9 frame delay. Not supported in this version of MPEG2 Decoder.
	IVIDDEC3_DISPLAY_DELAY_10	Display the frames with 10 frame delay. Not supported in this version of MPEG2 Decoder.
	IVIDDEC3_DISPLAY_DELAY_11	Display the frames with 11 frame delay. Not supported in this version of MPEG2 Decoder.
	IVIDDEC3_DISPLAY_DELAY_12	Display the frames with 12 frame delay. Not supported in this version of MPEG2 Decoder.
	IVIDDEC3_DISPLAY_DELAY_13	Display the frames with 13 frame delay. Not supported in this version of MPEG2 Decoder.
	IVIDDEC3_DISPLAY_DELAY_14	Display the frames with 14 frame delay. Not supported in this version of MPEG2 Decoder.
	IVIDDEC3_DISPLAY_DELAY_15	Display the frames with 15 frame delay. Not supported in this version of MPEG2 Decoder.

Group or Enumeration Class	Symbolic Constant Name	Description or Evaluation
	IVIDDEC3_DISPLAY_DELAY_16	Display the frames with 16 frame delay. Not supported in this version of MPEG2 Decoder.
	IVIDDEC3_DISPLAYDELAY_DEFAULT	Same as IVIDDEC3_DISPLAY_DELAY_AUTO. Not supported in this version of MPEG2 Decoder.
XDM_DataFormat	XDM_BYTE	Big endian stream (default value)
	XDM_LE_16	16-bit little endian stream. Not supported in this version of MPEG2 Decoder.
	XDM_LE_32	32-bit little endian stream. Not supported in this version of MPEG2 Decoder.
	XDM_LE_64	64-bit little endian stream. Not supported in this version of MPEG2 Decoder.
	XDM_BE_16	16-bit big endian stream. Not supported in this version of MPEG2 Decoder.
	XDM_BE_32	32-bit big endian stream. Not supported in this version of MPEG2 Decoder.
	XDM_BE_64	64-bit big endian stream. Not supported in this version of MPEG2 Decoder.
XDM_ChromaFormat	XDM_YUV_420P	YUV 4:2:0 planar. Not supported in this version of MPEG2 Decoder.
	XDM_YUV_422P	YUV 4:2:2 planar. Not supported in this version of MPEG2 Decoder.
	XDM_YUV_422IBE	YUV 4:2:2 interleaved (big endian). Not supported in this version of MPEG2 Decoder.
	XDM_YUV_422ILE	YUV 4:2:2 interleaved (little endian) (default value). Not supported in this version of MPEG2 Decoder.
	XDM_YUV_444P	YUV 4:4:4 planar. Not supported in this version of MPEG2 Decoder.
	XDM_YUV_411P	YUV 4:1:1 planar. Not supported in this version of MPEG2 Decoder.

Group or Enumeration Class	Symbolic Constant Name	Description or Evaluation
	XDM_GRAY	Gray format. Not supported in this version of MPEG2 Decoder.
	XDM_RGB	RGB color format. Not supported in this version of MPEG2 Decoder.
	XDM_YUV_420SP	YUV 4:2:0 chroma semi-planar
	XDM_ARGB8888	ARGB8888 color format. Not supported in this version of MPEG2 Decoder.
	XDM_RGB555	RGB555 color format. Not supported in this version of MPEG2 Decoder.
	XDM_RGB565	RGB565 color format. Not supported in this version of MPEG2 Decoder.
	XDM_YUV_444ILE	YUV 4:4:4 interleaved (little endian) color format. Not supported in this version of MPEG2 Decoder.
XDM_MemoryType	XDM_MEMTYPE_ROW	Raw Memory Type (deprecated)
	XDM_MEMTYPE_RAW	Raw Memory Type i.e., Linear (standard) memory.
	XDM_MEMTYPE_TILED8	2D memory in 8-bit container of tiled memory space.
	XDM_MEMTYPE_TILED16	2D memory in 16-bit container of tiled memory space.
	XDM_MEMTYPE_TILED32	2D memory in 32-bit container of tiled memory space. Not supported in this version of MPEG2 Decoder.
	XDM_MEMTYPE_TILEDPAGE	2D memory in page container of tiled memory space.
XDM_CmdId	XDM_GETSTATUS	Query algorithm instance to fill <code>Status</code> structure
	XDM_SETPARAMS	Set run-time dynamic parameters via the <code>DynamicParams</code> structure
	XDM_RESET	Reset the algorithm.

Group or Enumeration Class	Symbolic Constant Name	Description or Evaluation
	XDM_SETDEFAULT	Initialize all fields in Params structure to default values specified in the library.
	XDM_FLUSH	Handle end of stream conditions. This command forces algorithm instance to output data without additional input.
	XDM_GETBUFINFO	Query algorithm instance regarding the properties of input and output buffers
	XDM_GETVERSION	Query the algorithm's version. The result will be returned in the data field of the Status structure. Application has to allocate memory for a buffer passed through data field. The minimum buffer size required is 96 bytes.
	XDM_GETCONTEXTINFO	Query a split codec part for its context needs. Not supported in this version of MPEG2 Decoder.
	XDM_GETDYNPARAMSDEFAULT	Query algorithm instance regarding the dynamic parameters default values.
	XDM_SETLATEACQUIREARG	Set an algorithm's 'late acquire' argument.
XDM_AccessMode	XDM_ACCESSMODE_READ	The algorithm read from the buffer using the CPU
	XDM_ACCESSMODE_WRITE	The algorithm wrote from the buffer using the CPU
XDM_ErrorBit	XDM_APPLIEDCONCEALMENT	Bit 9 1 - applied concealment 0 - Ignore
	XDM_INSUFFICIENTDATA	Bit 10 1 - Insufficient data 0 - Ignore
	XDM_CORRUPTEDDATA	Bit 11 1 - Data problem/corruption 0 - Ignore
	XDM_CORRUPTEDHEADER	Bit 12 1 - Header problem/corruption 0 - Ignore

Group or Enumeration Class	Symbolic Constant Name	Description or Evaluation
	XDM_UNSUPPORTEDINPUT	Bit 13 1 - Unsupported feature/parameter in input 0 - Ignore
	XDM_UNSUPPORTEDPARAM	Bit 14 1 - Unsupported input parameter or configuration 0 - Ignore
	XDM_FATALERROR	Bit 15 1 - Fatal error 0 - Recoverable error
IMPEG2VDEC_ExtendedErrorCodes	IMPEG2VDEC_ERR_UNSUPPORTED_VIDDEC3PARAMS	Bit 0 This error code has been deprecated.
	IMPEG2VDEC_ERR_UNSUPPORTED_VIDDEC3DYNAMICPARAMS	Bit 1 1 - Base class Dynamic params out of supported range 0 - Ignore
	IMPEG2VDEC_ERR_UNSUPPORTED_MPEG2DECDYNAMICPARAMS	Bit 2 1 - Extended class Dynamic params out of supported range 0 - Ignore
	IMPEG2VDEC_ERR_IMPROPER_DATASYNC_SETTING	Bit 3 This error code has been deprecated.
	IMPEG2VDEC_ERR_NOSLICE	Bit 4 1 - Illegal start code search error from ECD 0 - Ignore
	IMPEG2VDEC_ERR_SLICEHDR	Bit 5 1 - Illegal Slice start/End error from ECD 0 - Ignore
	IMPEG2VDEC_ERR_MBDATA	Bit 6 1 - Data error detected by ECD 0 - Recoverable error
	IMPEG2VDEC_ERR_UNSUPPORTED_FEATURE	Bit 7 1 - Unsupported header extensions and profile/levels 0 - Ignore

Group or Enumeration Class	Symbolic Constant Name	Description or Evaluation
	IMPEG2VDEC_ERR_STREAM_END	Bit 16 1 - End of stream Detected while parsing 0 - Ignore
	IMPEG2VDEC_ERR_UNSUPPRESSION	Bit 17 1 - Stream resolution out of create time range 0 - Ignore
	IMPEG2VDEC_ERR_STANDBY	Bit 18 1 - HDVICP2 not in standby on acquire 0 - Ignore
	IMPEG2VDEC_ERR_INVALID_MBOX_MESSAGE	Bit 19 1 - Message from icont to host not defined 0 - Recoverable error
	IMPEG2VDEC_ERR_HDVICP_RESET	Bit 20 1 - HDVICP2 reset API from host to RMAN failed 0 - Ignore
	IMPEG2VDEC_ERR_HDVICP_WAIT_NOT_CLEAN_EXIT	Bit 21 1 - Erroneous exit from the wait API from host to RMAN 0 - Ignore
	IMPEG2VDEC_ERR_SEQHDR	Bit 22 1 - Invalid values of the parameters in sequence header 0 - Ignore
	IMPEG2VDEC_ERR_GOP_PICTURE	Bit 23 1 - Invalid values of the parameters in GOP and picture headers 0 - Ignore
	IMPEG2VDEC_ERR_SEQLVL_EXTENSION	Bit 24 1 - Invalid values of the parameters in sequence level extension headers 0 - Recoverable error
	IMPEG2VDEC_ERR_PICLVL_EXTENSION	Bit 25 1 - Invalid values of the parameters in picture level extension headers 0 - Ignore
	IMPEG2VDEC_ERR_TRICK_MODE	Bit 26 1 - Denotes frame skipped/reference frame skipped in Trick mode 0 - Ignore

Group or Enumeration Class	Symbolic Constant Name	Description or Evaluation
	IMPEG2VDEC_ERR_PICSIZECHANGE	Bit 27 1 - Change in frame dimensions in repeat sequence header 0 - Ignore
	IMPEG2VDEC_ERR_SEMANTIC	Bit 28 1 - Semantic rules of a MPEG-2 stream not followed 0 - Ignore
	IMPEG2VDEC_ERR_DECODE_EXIT	Bit 29 1 - Decoder failed to consume all the input bytes / All Mbs not decoded. This has been added to detect the corruption of dimension parameters in header. 0 - Ignore
	IMPEG2VDEC_ERR_IRES_RESOURCE_HANDLE	Bit 30 1 - Invalid resource handle in IRES interface 0 - Ignore
	IMPEG2VDEC_ERR_IRES_RESOURCE_DESC	Bit 31 This error code has been deprecated.
Impeg2VDEC_ErrorStatus	MPEG2_ECD_ILLEGAL_EOM	Bit 0 of extendedErrorCode0 1 – ECD3 cannot find EOM, end of macroblock, at the end of macroblock when picture_type is D-picture 0 - Error not found
	MPEG2_ECD_ILLEGAL_EOB	Bit 1 of extendedErrorCode0 1 - ECD3 cannot find EOB, end of block, in a 64 coefficient block 0 - Error not found
	MPEG2_ECD_ILLEGAL_MP1_ESCAPE_LVL	Bit 2 of extendedErrorCode0 1 - Decoded level from MPEG-2 ESCAPE code is 0x000 or 0x800 0 - Error not found
	MPEG2_ECD_ILLEGAL_MP2_ESCAPE_LVL	Bit 3 of extendedErrorCode0 1 - Decoded level from MPEG-1 ESCAPE code is 0x0000 or 0x8000 0 - Error not found

Group or Enumeration Class	Symbolic Constant Name	Description or Evaluation
	MPEG2_ECD_ILLEGAL_MARKER_CONCEAL	Bit 4 of extendedErrorCode0 1 - Invalid parameter value in data 0 - Error not found
	MPEG2_ECD_ILLEGAL_MBTYPE_D_PICTURE	Bit 5 of extendedErrorCode0 1 - Invalid parameter value in data 0 - Error not found
	MPEG2_ECD_ILLEGAL_DCT_COEFF	Bit 6 of extendedErrorCode0 1 - Invalid parameter value in data 0 - Error not found
	MPEG2_ECD_ILLEGAL_CBP	Bit 7 of extendedErrorCode0 1 - Invalid parameter value in data 0 - Error not found
	MPEG2_ECD_ILLEGAL_MOTION_CODE	Bit 8 of extendedErrorCode0 1 - Invalid parameter value in data 0 - Error not found
	MPEG2_ECD_ILLEGAL_MB_TYPE	Bit 9 of extendedErrorCode0 1 - Invalid parameter value in data 0 - Error not found
	MPEG2_ECD_ILLEGAL_MB_ADDRESS_INCR	Bit 10 of extendedErrorCode0 1 - Invalid parameter value in data 0 - Error not found
	MPEG2_ECD_ILLEGAL_EOS	Bit 11 of extendedErrorCode0 1 - End of slice cannot be found at the end of picture 0 - Error not found
	MPEG2_ECD_ILLEGAL_QUANTIZER_SCALE_CODE	Bit 12 of extendedErrorCode0 1 - Decoded quantizer_scale_code is zero 0 - Error not found
	MPEG2_ECD_ILLEGAL_SLICE_START_POS	Bit 13 of extendedErrorCode0 1 - Showing that two data is mismatched. ECD3 uses macroblock position in ECD3 ON registers and continue processing. 0 - Error not found

Group or Enumeration Class	Symbolic Constant Name	Description or Evaluation
	MPEG2_ECD_ILLEGAL_START_CODE_SEARCH	Bit 14 of extendedErrorCode0 1 – Showing next start code searching infinite error 0 - Error not found
	MPEG2_ECD_ILLEGAL_DC_COEFF_OVFL	Bit 15 1 – Result of DC prediction is overflow or underflow 0 - Error not found
	MPEG2_DYNAMIC_PARAMS_HANDLE_ERROR	Bit 16 of extendedErrorCode0 1 – Dynamic parameters handle NULL 0 - Error not found
	MPEG2_STATUS_HANDLE_ERROR	Bit 17 of extendedErrorCode0 This error code has been deprecated.
	MPEG2_DYNAMIC_PARAMS_SIZE_ERROR	Bit 18 of extendedErrorCode0 1 – Dynamic params size neither base class or extended class size 0 - Error not found
	MPEG2_STATUS_SIZE_ERROR	Bit 19 of extendedErrorCode0 This error code has been deprecated.
	MPEG2_DECODE_HEADER_ERROR	Bit 20 of extendedErrorCode0 1 – DynamicParams.decodeHeader value out of supported range 0 - Error not found
	MPEG2_DISPLAY_WIDTH_ERROR	Bit 21 of extendedErrorCode0 1 – DynamicParams.displayWidth value out of supported range 0 - Error not found
	MPEG2_FRAME_SKIP_MODE_ERROR	Bit 22 of extendedErrorCode0 1 – DynamicParams.frameSkipMode value out of supported range 0 - Error not found

Group or Enumeration Class	Symbolic Constant Name	Description or Evaluation
	MPEG2_NEW_FRAME_FLAG_ERROR	Bit 23 of extendedErrorCode0 1 – DynamicParams.newFrameFlag value out of supported range 0 - Error not found
	MPEG2_GOTO_IFRAME_ERROR	Bit 24 of extendedErrorCode0 1 – Extended Dynamic param gotoNextIframe out of supported range 0 - Error not found
	MPEG2_SKIP_BFRAME_ERROR	Bit 25 of extendedErrorCode0 1 – Extended Dynamic param skipBFrame out of supported range 0 - Error not found
	MPEG2_SKIP_CURRENTFRAME_ERROR	Bit 26 of extendedErrorCode0 1 – Extended Dynamic param skipCurrFrame out of supported range 0 - Error not found
	MPEG2_SEEK_FRAMEEND_ERROR	Bit 27 of extendedErrorCode0 1 – Extended Dynamic param seekFrameEnd out of supported range 0 - Error not found
	MPEG2_NULL_STATUS_DATA_BUF	Bit 28 of extendedErrorCode0 1 – Data Buffer pointer in status structure NULL in GETVERSION control call 0 - Error not found
	MPEG2_INSUFFICIENT_STATUS_DATA_BUF	Bit 29 of extendedErrorCode0 1 – Data buffers within status structure less than 96 bytes during getversion control call 0 - Error not found
	MPEG2_NULL_INARGS_POINTER_ERROR	Bit 30 of extendedErrorCode0 1 – InArgs pointer in process call NULL 0 - Error not found

Group or Enumeration Class	Symbolic Constant Name	Description or Evaluation
	MPEG2_INARGS_SIZE_ERROR	<p>Bit 31 of extendedErrorCode0</p> <p>1 – InArgs size in process call neither base class size nor extended class size 0 - Error not found</p>
	MPEG2_INVALID_INPUT_BYTES_ERROR	<p>Bit 0 of extendedErrorCode1</p> <p>1 – Non-positive value of the input bytes(plnArgs->numBytes) to process call 0 - Error not found</p>
	MPEG2_INVALID_INPUT_ID_ERROR	<p>Bit 1 of extendedErrorCode1</p> <p>1 – The input ID of output buffer is 0 0 - Error not found</p>
	MPEG2_DECODER_NOT_INITIALIZED_ERROR	<p>Bit 2 of extendedErrorCode1</p> <p>This error code has been deprecated.</p>
	MPEG2_NULL_INPUT_BUFFER_DESCRIPTOR_ERROR	<p>Bit 3 of extendedErrorCode1</p> <p>1 – Pointer to the Input Buffer descriptor is NULL 0 - Error not found</p>
	MPEG2_NULL_INPUT_BUFFER_POINTER_ERROR	<p>Bit 4 of extendedErrorCode1</p> <p>1 – Input buffer pointer is NULL 0 - Error not found</p>
	MPEG2_INVALID_INPUT_BUFFER_SIZE_ERROR	<p>Bit 5 of extendedErrorCode1</p> <p>1 – Invalid Input buffer size: when non-positive values for bytes in raw and dimensions in tiler 0 - Error not found</p>
	MPEG2_INVALID_NUM_OF_INPUT_BUFFERS_ERROR	<p>Bit 6 of extendedErrorCode1</p> <p>1 – Insufficient buffers (when number of Input Buffers less than 1) 0 - Error not found</p>
	MPEG2_EXCESS_NUM_OF_INPUT_BUFFERS_ERROR	<p>Bit 7 of extendedErrorCode1</p> <p>1 – Redundant input buffers (greater than 1) 0 - Error not found</p>

Group or Enumeration Class	Symbolic Constant Name	Description or Evaluation
	MPEG2_INVALID_INPUT_BUFFER_MEMTYPE_ERROR	Bit 8 of extendedErrorCode1 1 – Input stream buffer memory type other than RAW/Page mode 0 - Error not found
	MPEG2_NULL_OUTARGS_POINTER_ERROR	Bit 9 of extendedErrorCode1 1 – OutArgs pointer is NULL 0 - Error not found
	MPEG2_INVALID_OUTARGS_SIZE	Bit 10 of extendedErrorCode1 1 – OutArgs size set to value other than base class or extended class size 0 - Error not found
	MPEG2_NULL_OUTPUT_BUFFER_DESCRIPTOR_POINTER_ERROR	Bit 11 of extendedErrorCode1 1 – The Display buffer descriptor pointer in OutArgs is NULL 0 - Error not found
	MPEG2_NULL_OUTPUT_BUFFER_DESCRIPTOR_ERROR	Bit 12 of extendedErrorCode1 1 – The Output buffer descriptor pointer provided in process call is NULL 0 - Error not found
	MPEG2_INVALID_OUTPUT_BUFFER_POINTER_ERROR	Bit 13 of extendedErrorCode1 1 – Luma output buffer pointer is NULL 0 - Error not found
	MPEG2_INVALID_OUTPUT_BUFFER_SIZE_ERROR	Bit 14 of extendedErrorCode1 1 – Luma output buffer size/dimensions being non-positive 0 - Error not found
	MPEG2_INVALID_NUM_OF_OUTPUT_BUFFERS_ERROR	Bit 15 of extendedErrorCode1 1 – Number of Output buffers other than 2 (3 in metadataType Mbinfo) 0 - Error not found
	MPEG2_INVALID_OUTPUT_BUFFER_MEMTYPE_ERROR	Bit 16 of extendedErrorCode1 1 – Luma buffer memory other than Raw, tiled8, and tiledpage mode 0 - Error not found

Group or Enumeration Class	Symbolic Constant Name	Description or Evaluation
	MPEG2_INVALID_OUTPUT_BUFFER0_ALIGNMENT_ERROR	Bit 17 of extendedErrorCode1 1 – Luma buffer base address not 128-bit aligned 0 - Error not found
	MPEG2_INVALID_OUTPUT_BUFFER1_POINTER_ERROR	Bit 18 of extendedErrorCode1 1 – Chroma output buffer pointer is NULL 0 - Error not found
	MPEG2_INVALID_OUTPUT_BUFFER1_SIZE_ERROR	Bit 19 of extendedErrorCode1 1 –Chroma output buffer size/dimensions being non-positive 0 - Error not found
	MPEG2_INVALID_OUTPUT_BUFFER1_MEMTYPE_ERROR	Bit 20 of extendedErrorCode1 1 – Chroma buffer memory other than Raw, tiled 8, tiled16 and page mode 0 - Error not found
	MPEG2_INVALID_OUTPUT_BUFFER1_ALIGNMENT_ERROR	Bit 21 of extendedErrorCode1 1 – Chroma buffer base address not 128-bit aligned 0 - Error not found
	MPEG2_INVALID_OUTPUT_BUFFER2_POINTER_ERROR	Bit 22 of extendedErrorCode1 1 – MBinfo output buffer pointer is NULL in metadataType Mbinfo mode 0 - Error not found
	MPEG2_INVALID_OUTPUT_BUFFER2_SIZE_ERROR	Bit 23 of extendedErrorCode1 1 – MBinfo output buffer size is non-positive in metadataType Mbinfo mode 0 - Error not found
	MPEG2_INVALID_OUTPUT_BUFFER2_MEMTYPE_ERROR	Bit 24 of extendedErrorCode1 1 – MBinfo output buffer memory type other than RAW in metadataType Mbinfo mode 0 - Error not found
	MPEG2_INVALID_BUFFER_USAGE_MODE	Bit 25 of extendedErrorCode1 This error code has been deprecated.

Group or Enumeration Class	Symbolic Constant Name	Description or Evaluation
	MPEG2_SEQ_HDR_INVALID_FRAME_WIDTH	Bit 26 of extendedErrorCode1 1 – Frame width from header being 0 or greater than max width provided at create time 0 - Error not found
	MPEG2_SEQ_HDR_INVALID_FRAME_HEIGHT	Bit 27 of extendedErrorCode1 1 – Frame height from header being 0 or greater than max height provided at create time 0 - Error not found
	MPEG2_SEQ_HDR_INVALID_ASPECT_RATIO	Bit 28 of extendedErrorCode1 1 – Aspect ratio from sequence header is not standard compliant 0 - Error not found
	MPEG2_SEQ_HDR_INVALID_FRAME_RATE_CODE	Bit 29 of extendedErrorCode1 1 – Frame rate code from sequence header not standard compliant 0 - Error not found
	MPEG2_INVALID_INTRA_QUANT_MAT	Bit 30 of extendedErrorCode1 1 – Intra quantization matrix in sequence header or quantization matrix extension is not standard compliant 0 - Error not found
	MPEG2_INVALID_NON_INTRA_QUANT_MAT	Bit 31 of extendedErrorCode1 1 – Non-Intra quantization matrix in sequence header or quantization matrix extension is not standard compliant 0 - Error not found
	MPEG2_SEQ_HDR_INVALID_INTRA_ESCAPE_BIT	Bit 0 of extendedErrorCode2 1 – Escape bit in ProfileandLevel indication of sequence extension is not standard compliant 0 - Error not found
	MPEG2_SEQ_HDR_INVALID_PROFILE	Bit 1 of extendedErrorCode2 1 – Unsupported Profile, other than simple and main 0 - Error not found

Group or Enumeration Class	Symbolic Constant Name	Description or Evaluation
	MPEG2_SEQ_HDR_INVALID_LEVEL	Bit 2 of extendedErrorCode2 1 – Invalid level indication in sequence extension 0 - Error not found
	MPEG2_SEQ_HDR_INVALID_RESOLUTION_FORLVL	Bit 3 of extendedErrorCode2 1 – Level based resolution constraints violated 0 - Error not found
	MPEG2_SEQ_HDR_INVALID_CHROMA_FORMAT	Bit 4 of extendedErrorCode2 1 – Chroma format in sequence extension other than 4:2:0 0 - Error not found
	MPEG2_SEQ_HDR_INVALID_LOW_DELAY	Bit 5 of extendedErrorCode2 1 – Low-delay flag set to '1' in sequence extension not supported 0 - Error not found
	MPEG2_SEQ_DSP_INVALID_VIDEO_FORMAT	Bit 6 of extendedErrorCode2 1 – Video format parameter in sequence display extension not standard compliant 0 - Error not found
	MPEG2_SEQ_DSP_INVALID_COLOUR_PRIM	Bit 7 of extendedErrorCode2 1 – Colour primaries parameter in sequence display extension not standard compliant 0 - Error not found
	MPEG2_SEQ_DSP_INVALID_TRANSFER_CHARS	Bit 8 of extendedErrorCode2 1 – Transfer characteristics parameter in sequence display extension not standard compliant 0 - Error not found
	MPEG2_SEQ_DSP_INVALID_MATRIX_COEFFS	Bit 9 of extendedErrorCode2 1 – Matrix coefficients for colour conversion in sequence display extension not standard compliant 0 - Error not found
	MPEG2_GOP_HDR_INVALID_DROP_FLAG	Bit 10 of extendedErrorCode2 1 – The drop flag in GOP header set when frame rate is not 29.97 Hz 0 - Error not found

Group or Enumeration Class	Symbolic Constant Name	Description or Evaluation
	MPEG2_GOP_HDR_INVALID_HOUR	Bit 11 of extendedErrorCode2 1 – Invalid 'hour' parameter in GOP header 0 - Error not found
	MPEG2_GOP_HDR_INVALID_MIN	Bit 12 of extendedErrorCode2 1 – Invalid 'minute' parameter in GOP header 0 - Error not found
	MPEG2_GOP_HDR_INVALID_SECOND	Bit 13 of extendedErrorCode2 1 – Invalid 'second' parameter in GOP header 0 - Error not found
	MPEG2_GOP_HDR_INVALID_TIME_CODE_PICTURES	Bit 14 of extendedErrorCode2 1 – Invalid 'frame' parameter in GOP header 0 - Error not found
	MPEG2_GOP_HDR_INVALID_BROKEN_LINK	Bit 15 of extendedErrorCode2 1 – broken link in GOP header for a closed GOP 0 - Error not found
	MPEG2_PIC_HDR_INVALID_TEMP_REF	Bit 16 of extendedErrorCode2 This error code has been deprecated.
	MPEG2_PIC_HDR_INVALID_PICTURE_TYPE	Bit 17 of extendedErrorCode2 1 – Invalid picture type code: D-picture in MPEG2 and B-picture in MPEG1 simple profile. 0 - Error not found
	MPEG2_PIC_HDR_INVALID_VBV_DELAY	Bit 18 of extendedErrorCode2 This error code has been deprecated.
	MPEG1_PIC_HDR_INVALID_FORWARD_CODE	Bit 19 of extendedErrorCode2 1 – Forward f-code in picture header for B/P pictures is '0' 0 - Error not found

Group or Enumeration Class	Symbolic Constant Name	Description or Evaluation
	MPEG1_PIC_HDR_INVALID_BWD_FCODE	Bit 20 of extendedErrorCode2 1 – Backward f-code in picture header for B pictures is '0' 0 - Error not found
	MPEG2_PIC_HDR_INVALID_FCODE	Bit 21 of extendedErrorCode2 1 – Invalid fcode values in picture extension 0 - Error not found
	MPEG2_PIC_HDR_INVALID_PICTURE_STRUCTURE	Bit 22 of extendedErrorCode2 1 – Invalid picture_structure value in picture extension. Also, progressive sequence has to contain 'frame' pictures. 0 - Error not found
	MPEG2_PIC_HDR_INVALID_FIELD_COMB	Bit 23 of extendedErrorCode2 1 – Picture type combinations for filed pictures not standard compliant. Valid types: II, IP, PP, BB 0 - Error not found
	MPEG2_PIC_HDR_INVALID_TOP_FIELD	Bit 24 of extendedErrorCode2 1 – Top_field_first flag in picture coding extension not standard compliant 0 - Error not found
	MPEG2_PIC_HDR_INVALID_FRAME_PREDICTOR	Bit 25 of extendedErrorCode2 1 – framePredFrameDct flag in picture coding extension not standard compliant: has to be '1' for progressive sequence; has to be '0' for field pictures 0 - Error not found
	MPEG2_PIC_HDR_INVALID_REPEAT_FIRST_FIELD	Bit 26 of extendedErrorCode2 1 – RepeatFirstField flag in picture coding extension had to be '0' for a progressive sequence 0 - Error not found
	MPEG2_PIC_HDR_INVALID_PICTURE_STRUCTURE_FLAG	Bit 27 of extendedErrorCode2 1 – Picture structure has to be 'frame' in a progressive frame 0 - Error not found

Group or Enumeration Class	Symbolic Constant Name	Description or Evaluation
	MPEG2_QUANT_EXT_INVALID_LOAD_CHROMA_INTRA_FLAG	Bit 28 of extendedErrorCode2 1 – load_chroma_intra_quantizer_matrix shall be '0' for 4:2:0 format 0 - Error not found
	MPEG2_QUANT_EXT_INVALID_LOAD_CHROMA_NON_INTRA_FLAG	Bit 29 of extendedErrorCode2 1 – load_chroma_non_intra_quantizer_matrix shall be '0' for 4:2:0 format 0 - Error not found
	MPEG2_INVALID_EXTN_CODE	Bit 30 of extendedErrorCode2 1 – Undefined header extension code 0 - Error not found
	MPEG2_SEQ_HDR_MISSING	Bit 31 of extendedErrorCode2 1 – Picture header is encountered before sequence header 0 - Error not found
	MPEG2_NO_PICTURE_ENCODED_ERROR	Bit 0 of extendedErrorCode3 This error code has been deprecated.
	MPEG2_SEQ_EXT_MISSING	Bit 1 of extendedErrorCode3 1 – Occurrence of picture coding extension without sequence extension 0 - Error not found
	MPEG2_PIC_CODING_EXT_MISSING	Bit 2 of extendedErrorCode3 This error code has been deprecated.
	MPEG2_SEQ_DISP_EXT_MISSING	Bit 3 of extendedErrorCode3 This error code has been deprecated.
	MPEG2_GOP_FIRST_FRAME_NOT_I	Bit 4 of extendedErrorCode3 1 – First picture of a GOP not an I picture 0 - Error not found

Group or Enumeration Class	Symbolic Constant Name	Description or Evaluation
	MPEG2_SCALABILITY_NOT_SUPPORTED	Bit 5 of extendedErrorCode3 1 – Scalable extensions not supported, hence just parsed 0 - Error not found
	MPEG2_END_OF_SEQ_DETECTED	Bit 6 of extendedErrorCode3 1 – Sequence end code detected on parsing 0 - Error not found
	MPEG2_PIC_HDR_RFF_FRAME_RATE_MISMATCH	Bit 7 of extendedErrorCode3 1 – Standard defined dependency of repeatFirstField flag on frame rate violated 0 - Error not found
	MPEG2_PIC_HDR_INVALID_DC_PRECISION	Bit 8 of extendedErrorCode3 1 – intraDcPrecision decides the scaling factor in the inverse quantization process for the DC coefficient of an intra block. This has an invalid value. 0 - Error not found
	MPEG2_INVALID_FRAME_RATE	Bit 9 of extendedErrorCode3 1 – Frame rate from header is '0' or greater than the max value set during create time 0 - Error not found
	MPEG2_INVALID_BIT_RATE	Bit 10 of extendedErrorCode3 1 – Bit-rate from header is '0' or greater than the max value set during create time 0 - Error not found
	MPEG2_FRAME_SKIPPED	Bit 11 of extendedErrorCode3 1 – Indicates that the current picture has been skipped from decoding in trick mode 0 - Error not found
	MPEG2_REF_FRAME_SKIPPED	Bit 12 of extendedErrorCode3 1 – Indicates that the reference picture for P/B picture has been skipped under trick mode 0 - Error not found

Group or Enumeration Class	Symbolic Constant Name	Description or Evaluation
	MPEG2_NO_REF_TO_FLUSH	Bit 13 of extendedErrorCode3 1 – No more reference pictures held by the codec to provide in the flush call 0 - Error not found
	MPEG2_EXCESS_INPUT_BYTES	Bit 14 of extendedErrorCode3 1 – Entire input bytes have not been consumed by the codec 0 - Error not found
	MPEG2_ALL_MBS_NOT_DECODED	Bit 15 of extendedErrorCode3 1 – Number of decoded MBs is lesser than the expected number of MBs in the picture 0 - Error not found
	MPEG2_NO_REF_PFRAME	Bit 16 of extendedErrorCode3 1 - No reference pictures for P Frame. 0 - Error not found
	MPEG2_NO_REF_PFRAME	Bit 17 of extendedErrorCode3 1 - No reference pictures for B Frame 0 - Error not found
XDM_MemoryUsageMode	XDM_MEMUSAGE_DATASYNC	Bit 0 - Data Sync mode. If this bit is set, the memory will be used in data sync mode. Data sync feature is not supported in this version of MPEG-2 decoder.

4.2 Data Structures

This section describes the XDM defined data structures, which are common across codec classes. These XDM data structures can be extended to define any implementation specific parameters for a codec component.

4.2.1 Common XDM Data Structures

This section includes the following common XDM data structures:

- ❑ XDM2_SingleBufDesc
- ❑ XDM2_BufDesc
- ❑ XDM1_AlgBufInfo
- ❑ IVIDEO2_BufDesc

- ❑ IVIDDEC3_Fxns
- ❑ IVIDDEC3_Params
- ❑ IVIDDEC3_DynamicParams
- ❑ IVIDDEC3_InArgs
- ❑ IVIDDEC3_Status
- ❑ IVIDDEC3_OutArgs

4.2.1.1 XDM2_SingleBufDesc

|| Description

This structure defines the buffer descriptor for single input and output buffers.

|| Fields

Field	Data Type	Input/Output	Description
*buf	XDAS_Int8	Input	Pointer to the buffer
memType	XDAS_Int16	Input	Type of memory. See XDM_MemoryType enumeration for more details.
usageMode	XDAS_Int16	Input	Memory usage descriptor.
bufSize	XDM2_BufSize	Input	Size of the buffer(for tile memory/row memory)
accessMask	XDAS_Int32	Output	If the buffer was not accessed by the algorithm processor (for example, it was filled by DMA or other hardware accelerator that does not write through the algorithm CPU), then bits in this mask should not be set.

4.2.1.2 XDM2_BufSize

|| Description

This defines the union describing a buffer size.

|| Fields

Field	Data Type	Input/Output	Description
width	XDAS_Int32	Input	Width of buffer in 8-bit bytes. Required only for tiled memory.
height	XDAS_Int32	Input	Height of buffer in 8-bit bytes. Required only for tiled memory.

Field	Data Type	Input/Output	Description
bytes	XDM2_BufSize	Input	Size of the buffer in bytes

4.2.1.3 XDM2_BufDesc

|| Description

This structure defines the buffer descriptor for output buffers.

|| Fields

Field	Data Type	Input/Output	Description
numBufs	XDAS_Int32	Input	Number of buffers
descs[XDM_MAX_IO_BUFFERS]	XDM2_SingleBufDesc	Input	Array of buffer descriptors

4.2.1.4 XDM1_AlgBufInfo

|| Description

This structure defines the buffer information descriptor for input and output buffers. This structure is filled when you invoke the `control()` function with the `XDM_GETBUFINFO` command.

|| Fields

Field	Data Type	Input/Output	Description
minNumInBufs	XDAS_Int32	Output	Number of input buffers
minNumOutBufs	XDAS_Int32	Output	Number of output buffers
minInBufSize[XDM_MAX_IO_BUFFERS]	XDM2_BufSize	Output	Size required for each input buffer
minOutBufSize[XDM_MAX_IO_BUFFERS]	XDM2_BufSize	Output	Size required for each output buffer
inBufMemoryType[XDM_MAX_IO_BUFFERS]	XDAS_Int32	Output	Memory type for each input buffer
outBufMemoryType[XDM_MAX_IO_BUFFERS]	XDAS_Int32	Output	Memory type for each output buffer
minNumBufSets	XDAS_Int32	Output	Minimum number of buffer sets for buffer management

Note:

- ❑ For MPEG2 Main Profile Decoder, the buffer details are:
 - ❑ Number of input buffer required is 1.
 - ❑ Number of output buffers required is 2 if no metadata is requested by the application (one for Y plane and 1 for Cb/Cr plane).
 - ❑ For frame mode of operation, there is no restriction on input buffer size except that it should contain atleast one frame of encoded data.
 - ❑ The output buffer sizes (in bytes) for a resolution (X,Y) are
 - Y buffer = ((ROUND_TO_NEXT_MULT16(X)+2) * (ROUND_TO_NEXT_MULT16(Y)+2))
 - UV buffer = ((ROUND_TO_NEXT_MULT16(X)+2) * (ROUND_TO_NEXT_MULT16(Y)/2 +2))
 - Example: Output buffer sizes required for 1080p are
 - Y buffer = (1920 + 2) * (1088 + 2)
 - UV buffer = (1920 + 2) * (544 + 2)
 - ❑ These are the maximum buffer sizes but they can be reconfigured depending on the format of the bit-stream.
 - ❑ The memory types supported for input buffers are `XDM_MEMTYPE_RAW` and `XDM_MEMTYPE_TILEDPAGE`.
 - ❑ The memory types supported for luma output buffers are `XDM_MEMTYPE_TILED8`, `XDM_MEMTYPE_TILEDPAGE` and `XDM_MEMTYPE_RAW`.
 - ❑ The memory types supported for chroma output buffers are `XDM_MEMTYPE_TILED8`, `XDM_MEMTYPE_TILED16`, `XDM_MEMTYPE_TILEDPAGE` and `XDM_MEMTYPE_RAW`.

4.2.1.5 IVIDEO2_BufDesc**|| Description**

This structure defines the buffer descriptor for input and output buffers.

|| Fields

Field	Data Type	Input/Output	Description
<code>numPlanes</code>	<code>XDAS_Int32</code>	Input/Output	Number of buffers for video planes
<code>numMetaPlanes</code>	<code>XDAS_Int32</code>	Input/Output	Number of buffers for Metadata
<code>dataLayout</code>	<code>XDAS_Int32</code>	Input/Output	Video buffer layout. See <code>IVIDEO_VideoLayout</code> enumeration for more details
<code>planeDesc</code> [<code>IVIDEO_MAX_NUM_PLANES</code>]	<code>XDM1_SingleBufDesc</code>	Input/Output	Description for video planes

Field	Data Type	Input/Output	Description
metadataPlaneDesc [IVIDEO_MAX_NUM_METADATA_PLANES]	XDM1_SingleBufDesc	Input/Output	Description for metadata planes
secondFieldOffsetWidth[IVIDEO_MAX_NUM_PLANES]	XDAS_Int32	Input/Output	Offset value for second field in planeDesc buffer (width in pixels)
secondFieldOffsetHeight[IVIDEO_MAX_NUM_PLANES]	XDAS_Int32	Input/Output	Offset value for second field in planeDesc buffer (height in lines)
imagePitch	XDAS_Int32[]	Input/Output	Image pitch for each plane
imageRegion	XDM_Rect	Input/Output	Decoded image region including padding /encoder input image
activeFrameRegion	XDM_Rect	Input/Output	Actual display region/capture region
extendedError	XDAS_Int32	Input/Output	Provision for informing the error type if any
frameType	XDAS_Int32	Input/Output	Video frame types. See enumeration IVIDEO_FrameType. Not applicable for encoders
topFieldFirstFlag	XDAS_Int32	Input/Output	Indicates when the application (should display)/(had captured) the top field first. Not applicable for progressive content.
repeatFirstFieldFlag	XDAS_Int32	Input/Output	Indicates when the first field should be repeated.
frameStatus	XDAS_Int32	Input/Output	Video in/out buffer status.
repeatFrame	XDAS_Int32	Input/Output	Number of times to repeat the displayed frame.
contentType	XDAS_Int32	Input/Output	Video content type. See IVIDEO_ContentType.
chromaFormat	XDAS_Int32	Input/Output	Chroma format for encoder input data/decoded output buffer. See XDM_ChromaFormat enumeration for details.
scalingWidth	XDAS_Int32	Input/Output	Scaled image width for post processing for decoder.

Field	Data Type	Input/Output	Description
scalingHeight	XDAS_Int32	Input/Output	Scaled image height for post processing for decoder.
rangeMappingLuma	XDAS_Int32	Input/Output	Applicable for VC1, set to -1 as default for other codecs
rangeMappingChroma	XDAS_Int32	Input/Output	Applicable for VC1, set to -1 as default for other codecs
enableRangeReductionFlag	XDAS_Int32	Input/Output	ON/OFF, default is OFF. Applicable only for VC1.

Note:

- ❑ IVIDEO_MAX_NUM_PLANES: Max YUV buffers - one each for Y, U, and V.
- ❑ The following parameters are not supported/updated in this version of the decoder
 - scalingWidth
 - scalingHeight
 - rangeMappingLuma
 - rangeMappingChroma
 - enableRangeReductionFlag

4.2.1.6 IVIDDEC3_Fxns**|| Description**

This structure contains pointers to all the XDAIS and XDM interface functions.

|| Fields

Field	Data Type	Input/Output	Description
ialg	IALG_Fxns	Input	Structure containing pointers to all the XDAIS interface functions. For more details, see <i>TMS320 DSP Algorithm Standard API Reference</i> (literature number SPRU360).
*process	XDAS_Int32	Input	Pointer to the <code>process()</code> function

Field	Data Type	Input/Output	Description
*control	XDAS_Int32	Input	Pointer to the <code>control()</code> function

4.2.1.7 *IVIDDEC3_Params*

|| Description

This structure defines the creation parameters for an algorithm instance object. Set this data structure to NULL, if you are not sure of the values to be specified for these parameters.

|| Fields

Field	Data Type	Input/Output	Description
size	XDAS_Int32	Input	Size of the basic or extended (if being used) data structure in bytes.
maxHeight	XDAS_Int32	Input	Maximum video height to be supported in pixels. The supported range is [64, 2048]. Default is 1088.
maxWidth	XDAS_Int32	Input	Maximum video width to be supported in pixels. The supported range is [64, 2048]. Default is 1920.
maxFrameRate	XDAS_Int32	Input	Maximum frame rate in fps * 1000 to be supported. Default is 30000.
maxBitRate	XDAS_Int32	Input	Maximum bit-rate to be supported in bits per second. For example, if bit-rate is 10 Mbps, set this field to 10485760. Default is 10000000.
dataEndianness	XDAS_Int32	Input	Should be set to <code>XDM_BYTE</code> .
forceChromaFormat	XDAS_Int32	Input	Sets the output to the specified format. Only 420 semi-planar format supported. Default is <code>XDM_YUV_420SP</code> . See <code>XDM_ChromaFormat</code> and <code>eChromaFormat_t</code> enumerations for details.
operatingMode	XDAS_Int32	Input	Video coding mode of operation (encode/decode/transcode/transrate). Only decode and transcode modes are supported in this version. Default is <code>IVIDDEC3_DECODE_ONLY</code> .
displayDelay	XDAS_Int32	Input	Display delay to start display. Supported values are <code>IVIDDEC3_DISPLAY_DELAY_AUTO</code> , <code>IVIDDEC3_DECODE_ORDER</code> and <code>IVIDDEC3_DISPLAY_DELAY_1</code> .

Field	Data Type	Input/Output	Description
			Default value is IVIDDEC3_DISPLAY_DELAY_1.
inputDataMode	XDAS_Int32	Input	Input mode of operation. For decoder, it is fixed length/slice mode/entire frame. This version of the decoder supports only the entire frame mode.
outputDataMode	XDAS_Int32	Input	Output mode of operation. For decoder, it is row mode/entire frame. This version of the decoder supports only the entire frame mode.
numInputDataUnits	XDAS_Int32	Input	Number of input slices/rows. Not applicable for this MPEG-2 Decoder as it does not support sub-frame data synchronization.
numOutputDataUnits	XDAS_Int32	Input	Number of output slices/rows. Not applicable for this MPEG-2 Decoder as it does not support sub-frame data synchronization.
errorInfoMode	XDAS_Int32	Input	Enable/disable packet error information for input/output. Only IVIDEO_ERRORINFO_OFF is supported.
displayBufsMode	XDAS_Int32	Input	Indicates the displayBufs mode. This field can be set either as IVIDDEC3_DISPLAYBUFS_EMBEDDED or IVIDDEC3_DISPLAYBUFS_PTRS. Default is IVIDDEC3_DISPLAYBUFS_PTRS.
metadataType	XDAS_Int32[]	Input	Type of each metadata plane. This field can be set to either IVIDEO_METADATAPLANE_MBINFO or IVIDEO_METADATAPLANE_NONE. Default is IVIDEO_METADATAPLANE_NONE.

Note:

- ❑ MPEG2 Decoder does not use the `maxFrameRate` and `maxBitRate` fields for creating the algorithm instance. In the current implementation, `maxFrameRate` is set to $1000 * 30$, and `maxBitRate` is set to 10000000.
- ❑ Maximum video height and width supported are 2048 pixels and 2048 pixels respectively.
- ❑ The minimum height and width supported is 64 pixels.
- ❑ `dataEndianness` field should be set to `XDM_BYTE`.
- ❑ The default value of `displayDelay` is 1.

❑ InputDataMode can be set to `IVIDEO_ENTIREFRAME` only.

4.2.1.8 *IVIDDEC3_DynamicParams*

|| Description

This structure defines the run-time parameters for an algorithm instance object. Set this data structure to `NULL`, if you are not sure of the values to be specified for these parameters.

|| Fields

Field	Data Type	Input/Output	Description
size	XDAS_Int 32	Input	Size of the basic or extended (if being used) data structure in bytes.
decodeHeader	XDAS_Int 32	Input	Number of access units to decode: 0 (<code>XDM_DECODE_AU</code>) - Decode entire frame including all the headers 1 (<code>XDM_PARSE_HEADER</code>) - Decode only one NAL unit or Parse the header only Default is <code>XDM_DECODE_AU</code> .
displayWidth	XDAS_Int 32	Input	If the field is set to: 0 - Uses decoded image width as pitch If any other value greater than the decoded image width is given, then this value in pixels is used as pitch. When the output buffer is in non-TILED region, display width should be multiple of 128. Default value is 0.
frameSkipMode	XDAS_Int 32	Input	Frame skip mode. See <code>IVIDEO_FrameSkip</code> enumeration for details.
newFrameFlag	XDAS_Int 32	Input	Flag to indicate that the algorithm should start a new frame. Valid values are <code>XDAS_TRUE</code> and <code>XDAS_FALSE</code> . This is useful for error recovery, for example, when the end of frame cannot be detected by the codec but is known to the application. Not supported in this decoder.
*putDataFxn	XDM_Data SyncPutFxn	Input	DataSync call back function pointer for <code>putData</code> . Not supported in this decoder.
putDataHandle	XDM_Data SyncHandle	Input	DataSync handle for <code>putData</code> . Not supported in this decoder.
*getDataFxn	XDM_Data SyncGetFxn	Input	DataSync call back function pointer for <code>getData</code> . Not supported in this decoder.

Field	Data Type	Input/Output	Description
getDataHandle	XDM_DataSyncHandle	Input	DataSync handle for <code>getData</code> . Not supported in this decoder.
putBufferFxn	XDM_DataSyncPutBufferFxn	Input	Not supported in this decoder.
putBufferHandle	XDM_DataSyncHandle	Input	Not supported in this decoder.
lateAcquireArg	XDAS_Int32	Input	Argument used during late acquire. Default value is <code>IRES_HDVICP2_UNKNOWNLATEACQUIREARG</code> .

Note:

- ❑ The decoder supports `displayWidth >= 0`. A value of 0 indicated the decoder will choose the `displaywidth` (`displaywidth = imagewidth`). The `displayWidth` should be `>= image width`. The default value of `displayWidth` is 0.
- ❑ MPEG2 Decoder does not support `newFrameFlag`. Their values are set as zero.
- ❑ In case of `XDM_PARSE_HEADER`, the application should provide a minimum of Sequence header including sequence extensions (if any) of the stream as input to the decoder.

4.2.1.9 IVIDDEC3_InArgs**|| Description**

This structure defines the run-time input arguments for an algorithm instance object.

|| Fields

Field	Data Type	Input/Output	Description
size	XDAS_Int32	Input	Size of the basic or extended (if being used) data structure in bytes.
numBytes	XDAS_Int32	Input	Size of input data (in bytes) provided to the algorithm for decoding
inputID	XDAS_Int32	Input	Application passes this ID to algorithm and decoder will attach this ID to the corresponding output frames. This is useful in case of re-ordering (for example, B frames). If there is no re-ordering, <code>outputID</code> field in the

			IVIDDEC3_OutArgs data structure will be same as inputID field.
--	--	--	----------------------------------------------------------------

Note:

MPEG2 Decoder copies the inputID value to the outputID value of IVIDDEC3_OutArgs structure after factoring in the display delay.

4.2.1.10**IVIDDEC3_Status****|| Description**

This structure defines parameters that describe the status of an algorithm instance object.

|| Fields

Field	Data Type	Input/Output	Description
Size	XDAS_Int32	Input	Size of the basic or extended (if being used) data structure in bytes.
extendedError	XDAS_Int32	Output	Extended error code. See XDM_ErrorBit enumeration for details.
data	XDM1_SingleBufDesc	Output	Buffer information structure for information passing buffer.
maxNumDisplayBufs	XDAS_Int32	Output	Maximum number of buffers required by the codec.
maxOutArgsDisplayBufs	XDAS_Int32	Output	The maximum number of display buffers that can be returned through IVIDDEC3_OutArgs.displayBufs.
outputHeight	XDAS_Int32	Output	Output height in pixels
outputWidth	XDAS_Int32	Output	Output width in pixels
frameRate	XDAS_Int32	Output	This value will be derived from VUI parameters as, $frameRate = time_scale / (2 * num_units_in_ticks)$. In case the VUI parameters are absent, the frameRate will be reported as 0, which should be inferred as 'not available'.
bitRate	XDAS_Int32	Output	Average bit-rate in bits per second

Field	Data Type	Input/Output	Description
contentType	XDAS_Int32	Output	Video content. See <code>IVIDEO_ContentType</code> enumeration for details.
sampleAspectRatioHeight	XDAS_Int32	Output	Sample aspect ratio for height
sampleAspectRatioWidth	XDAS_Int32	Output	Sample aspect ratio for width
bitRange	XDAS_Int32	Output	Bit range. It is set to <code>IVIDEO_YUVRANGE_FULL</code> .
forceChromaFormat	XDAS_Int32	Output	Output chroma format. See <code>XDM_ChromaFormat</code> and <code>eChromaFormat_t</code> enumeration for details.
operatingMode	XDAS_Int32	Output	Mode of operation: Encoder/Decoder/Transcode/Transrate. This decoder supports <code>IVIDEO_DECODE_ONLY</code> and <code>IVIDEO_TRANSCODE_FRAMELEVEL</code> only.
frameOrder	XDAS_Int32	Output	Indicates the output frame order. See <code>IVIDDEC3_displayDelay</code> enumeration for more details.
inputDataMode	XDAS_Int32	Output	Input mode of operation. For decoder, it is fixed length/slice mode/entire frame. This version of the decoder supports only the entire frame mode.
outputDataMode	XDAS_Int32	Output	Output mode of operation. For decoder, it is the row mode/entire frame. This version of the decoder supports only the entire frame mode.
bufInfo	XDM_AlgoBufInfo	Output	Input and output buffer information. See <code>XDM_AlgoBufInfo</code> data structure for details.
metadataType	XDAS_Int32[]	Input	Type of each metadata plane.
decDynamicParams	IVIDDEC3_DynamicParams	Output	Current values of the decoder's dynamic parameters.

Note:

- `frameOrder` field in the status structure is set to the actual display

delay value used by the decoder.

4.2.1.11 IVIDDEC3_OutArgs

|| Description

This structure defines the run-time output arguments for an algorithm instance object.

|| Fields

Field	Data Type	Input/Output	Description
size	XDAS_Int32	Input	Size of the basic or extended (if being used) data structure in bytes.
extendedError	XDAS_Int32	Output	extendedError Field
bytesConsumed	XDAS_Int32	Output	Bytes consumed per decode call
OutputID[IVIDEO2_MAX_IO_BUFFERS]	XDAS_Int32	Output	Output ID corresponding to displayBufs A value of zero (0) indicates an invalid ID. The first zero entry in array will indicate end of valid outputIDs within the array. Hence, the application can stop reading the array when it encounters the first zero entry.
decodedBufs	IVIDEO2_BufDesc	Output	The decoder fills this structure with buffer pointers to the decoded frame. Related information fields for the decoded frame are also populated. When frame decoding is not complete, as indicated by outBufsInUseFlag, the frame data in this structure will be incomplete. However, the algorithm will provide incomplete decoded frame data in case application may choose to use it for error recovery purposes.
freeBufID[IVIDEO2_MAX_IO_BUFFERS]	XDAS_Int32	Output	This is an array of inputIDs corresponding to the frames that have been unlocked in the current process call.
outBufsInUseFlag	XDAS_Int32	Output	Flag to indicate that the outBufs provided with the process() call are in use. No outBufs are required to be supplied with the next process() call.
displayBufsMode	XDAS_Int32	Output	Indicates which mode the displayBufs are presented in. See the note below for details.
bufDesc [1]	IVIDEO2_BufDesc	Output	Array containing display frames corresponding to valid ID entries in the outputID array. See IVIDEO2_BufDesc data structure for more details.
*pBufDesc[IVIDEO	IVIDEO2_Bu	Output	Array containing pointers to display frames

Field	Data Type	Input/ Output	Description
<code>2_MAX_IO_BUFFERS</code>]	<code>fDesc *</code>		corresponding to valid ID entries in the <code>@c</code> <code>outputID[]</code>

Note:

The display buffer mode can be set as either
`IVIDDEC3_DISPLAYBUFS_EMBEDDED` or
`IVIDDEC3_DISPLAYBUFS_PTRS`.

The current implementation of the decoder will always return a maximum of one display buffer per process call. If the mode is `IVIDDEC3_DISPLAYBUFS_EMBEDDED`, then the instance of the display buffer structure will be present in `OutArgs`. If the mode is `IVIDDEC3_DISPLAYBUFS_PTRS`, then a pointer to the instance will be present in `OutArgs`.

4.2.2 MPEG2 Decoder Data Structures

This section includes the following MPEG2 Decoder specific data structures:

- ❑ IMPEG2VDEC_Params
- ❑ IMPEG2VDEC_DynamicParams
- ❑ IMPEG2VDEC_InArgs
- ❑ IMPEG2VDEC_Status
- ❑ IMPEG2VDEC_OutArgs

4.2.2.1 IMPEG2VDEC_Params

|| Description

This structure defines the creation parameters and any other implementation specific parameters for an MPEG2 Decoder instance object. The creation parameters are defined in the XDM data structure, `IVIDDEC3_Params`.

|| Fields

Field	Data Type	Input/Output	Description
<code>viddec3Params</code>	<code>IVIDDEC3_Params</code>	Input	See <code>IVIDDEC3_Params</code> data structure for details.
<code>ErrorConcealmentON</code>	<code>XDAS_Int32</code>	Input	Set it to 1 to enable error concealment and 0 to disable error concealment. If the user wishes to enable error concealment, decoder needs to be operated in <code>IVIDEO_TRANSCODE_FRAMELEVEL</code> mode and application should provide a meta data buffer through process call. <code>metadataType</code> for this buffer should be set to <code>IVIDEO_METADATAPLANE_MBINFO</code> . Default value is 0.
<code>outloopDeblocking</code>	<code>XDAS_Int32</code>	Input	Enables/disables out-of-loop deblocking. Also specifies the strength of deblocking if enabled. 0-> Disable de-blocking 1-> Enable de-blocking : Minor 2-> Enable deblocking : Medium 3-> Enable de-blocking : High 4-> Enable deblocking : Strong Default value is 0.

Field	Data Type	Input/Output	Description
debugTraceLevel	XDAS_UInt32	Input	Specifies the debug trace level. MPEG-2 Decoder supports till level 4. Each higher level logs more debug trace data. Default value is 0 (no debug trace log).
lastNFramesToLog	XDAS_UInt32	Input	Specifies the number of most recent frames to log in debug trace. Minimum value supported is 0 and maximum value supported is 10. Default value is 0.

4.2.2.2 IMPEG2VDEC_DynamicParams

|| Description

This structure defines the run-time parameters and any other implementation specific parameters for an MPEG-2 instance object. The run-time parameters are defined in the XDM data structure, `IVIDDEC3_DynamicParams`.

|| Fields

Field	Data Type	Input/Output	Description
viddec3DynamicParams	IVIDDEC3_DynamicParams	Input	See <code>IVIDDEC3_DynamicParams</code> data structure for details.
gotoNextIFrame	XDAS_Int32	Input	If set to 1, only I frames are decoded and provided to the application for display. P/B frames are skipped. This continues until the flag is reset. Default value is 0.
skipBFrame	XDAS_Int32	Input	On setting this flag, decoder skips B frames encountered. It searches for the valid I/P frames and decodes them. This continues until the flag is reset. Default value is 0.
skipCurrFrame	XDAS_Int32	Input	If the flag is set, the current frame is skipped and decoding is continued from the next frame. Default value is 0.

Field	Data Type	Input/Output	Description
seekFrameEnd	XDAS_Int32	Input	“seekFrameEnd” is always used in conjunction with flags “gotoNextIframe”, “skipBFrame” or “skipCurrFrame”. If this flag is set to 1, decoder seeks to the frame end in case of P/B pictures without decoding and updates the bytes consumed accordingly. “. If this flag is set to 0, decoder just parses the picture type parameter and if the picture type is P/B picture, the decoder returns with bytes consumed set to zero. Default value is 1.

4.2.2.3 IMPEG2VDEC_InArgs

|| Description

This structure defines the run-time input arguments for an MPEG2 instance object.

|| Fields

Field	Data Type	Input/Output	Description
viddec3InArgs	IVIDDEC3_InArgs	Input	See IVIDDEC3_InArgs data structure for details.

4.2.2.4 IMPEG2VDEC_Status

|| Description

This structure defines parameters that describe the status of the MPEG2 Decoder and any other implementation specific parameters. The `status` parameters are defined in the XDM data structure, `IVIDDEC3_Status`.

|| Fields

Field	Data Type	Input/Output	Description
viddec3Status	IVIDDEC3_Status	Output	See IVIDDEC3_Status data structure for details
extendedError Code0	XDAS_UInt32	Output	Parameter added to capture specific errors not captured in base Status structure
extendedError Code1	XDAS_UInt32	Output	Parameter added to capture specific errors not captured in base Status structure
extendedError Code2	XDAS_UInt32	Output	Parameter added to capture specific errors not captured in base Status structure

Field	Data Type	Input/Output	Description
extendedError Code3	XDAS_UInt32	Output	Parameter added to capture specific errors not captured in base Status structure
debugTraceLevel	XDAS_UInt32	Output	Specifies the debug trace level. MPEG2 Decoder supports till level 4. Each higher level logs more debug trace data.
lastNFramesTo Log	XDAS_UInt32	Output	Specifies the number of most recent frames to log in debug trace.
extMemoryDebugTraceAddr	XDAS_UInt32 *	Output	Specifies the address of the debug trace dump in external memory.
extMemoryDebugTraceSize	XDAS_UInt32	Output	Specifies the size of the debug trace dump in external memory.

4.2.2.5 IMPEG2VDEC_OutArgs

|| Description

This structure defines the run-time output arguments for the MPEG2 Decoder instance object.

|| Fields

Field	Data Type	Input/Output	Description
viddec3OutArgs	IVIDDEC3_OutArgs	Output	See IVIDDEC3_OutArgs data structure for details.

4.3 Interface Functions

This section describes the application programming interfaces used in the MPEG2 Decoder. The MPEG2 Decoder APIs are logically grouped into the following categories:

- ❑ **Creation** – `algNumAlloc()`, `algAlloc()`
- ❑ **Initialization** – `algInit()`
- ❑ **Control** – `control()`
- ❑ **Data processing** – `algActivate()`, `process()`, `algDeactivate()`
- ❑ **Termination** – `algFree()`

You must call these APIs in the following sequence:

- 1) `algNumAlloc()`
- 2) `algAlloc()`
- 3) `algInit()`
- 4) `algActivate()`
- 5) `process()`
- 6) `algDeactivate()`
- 7) `algFree()`

`control()` can be called any time after calling the `algInit()` API.

4.3.1 Creation APIs

Creation APIs are used to create an instance of the component. The term creation could mean allocating system resources, typically memory.

|| Name

`algNumAlloc()` – determine the number of buffers that an algorithm requires

|| Synopsis

```
XDAS_Int32 algNumAlloc(Void);
```

|| Arguments

Void

|| Return Value

```
XDAS_Int32; /* number of buffers required */
```

|| Description

`algNumAlloc()` returns the number of buffers that the `algAlloc()` method requires. This operation allows you to allocate sufficient space to call the `algAlloc()` method.

`algNumAlloc()` may be called at any time and can be called repeatedly without any side effects. It always returns the same result. The `algNumAlloc()` API is optional.

For more details, see TMS320 DSP Algorithm Standard API Reference.

|| See Also

`algAlloc()`

|| Name

`algAlloc()` – determine the attributes of all buffers that an algorithm requires

|| Synopsis

```
XDAS_Int32 algAlloc(const IALG_Params *params, IALG_Fxns
**parentFxns, IALG_MemRec memTab[]);
```

|| Arguments

```
IALG_Params *params; /* algorithm specific attributes */
```

```
IALG_Fxns **parentFxns; /* output parent algorithm functions
*/
```

```
IALG_MemRec memTab[]; /* output array of memory records */
```

|| Return Value

```
XDAS_Int32 /* number of buffers required */
```

|| Description

`algAlloc()` returns a table of memory records that describe the size, alignment, type, and memory space of all buffers required by an algorithm. If successful, this function returns a positive non-zero value indicating the number of records initialized.

The first argument to `algAlloc()` is a pointer to a structure that defines the creation parameters. This pointer may be `NULL`; however, in this case, `algAlloc()`, must assume default creation parameters and must not fail.

The second argument to `algAlloc()` is an output parameter. `algAlloc()` may return a pointer to its parent's IALG functions. Since the client does not require a parent object to be created, this pointer must be set to `NULL`.

The third argument is a pointer to a memory space of size `nbufs * sizeof(IALG_MemRec)` where, `nbufs` is the number of buffers returned by `algNumAlloc()` and `IALG_MemRec` is the buffer-descriptor structure defined in `ialg.h`.

After calling this function, `memTab[]` is filled up with the memory requirements of an algorithm.

For more details, see TMS320 DSP Algorithm Standard API Reference.

Note:

If you are using extended data structures, the first argument must be a pointer to the extended `Params` data structure. Also, ensure that the `size` field is set to the size of the extended data structure. Depending on the value set for the `size` field, the algorithm uses either base or extended parameters.

|| See Also

`algNumAlloc()`, `algFree()`

4.3.2 Initialization API

Initialization API is used to initialize an instance of the MPEG2 Decoder. The initialization parameters are defined in the `IVIDDEC3_Params` structure (see Data Structures section for details).

|| Name

`algInit()` – initialize an algorithm instance

|| Synopsis

```
XDAS_Int32 algInit(IALG_Handle handle, IALG_MemRec
memTab[], IALG_Handle parent, IALG_Params *params);
```

|| Arguments

```
IALG_Handle handle; /* handle to the algorithm instance*/
IALG_MemRec memTab[]; /* array of allocated buffers */
IALG_Handle parent; /* handle to the parent instance */
IALG_Params *params; /*algorithm initialization parameters*/
```

|| Return Value

```
IALG_EOK; /* status indicating success */
```

```
IALG_EFAIL; /* status indicating failure */
```

|| Description

`algInit()` performs all initialization necessary to complete the run-time creation of an algorithm instance object. After a successful return from `algInit()`, the instance object is ready to be used to process data.

The first argument to `algInit()` is a handle to an algorithm instance. This value is initialized to the base field of `memTab[0]`.

The second argument is a table of memory records that describe the base address, size, alignment, type, and memory space of all buffers allocated for an algorithm instance. The number of initialized records is identical to the number returned by a prior call to `algAlloc()`.

The third argument is a handle to the parent instance object. If there is no parent object, this parameter must be set to `NULL`.

The last argument is a pointer to a structure that defines the algorithm initialization parameters. All fields in the `params` structure must be set as described in `IALG_Params` structure (see Data Structures section for details).

For more details, see TMS320 DSP Algorithm Standard API Reference.

Note:

If you are using extended data structures, the fourth argument must be a pointer to the extended Params data structure. Also, ensure that the size field is set to the size of the extended data structure. Depending on the value set for the size field, the algorithm uses either base or extended parameters.

|| See Also

`algAlloc()`, `algMoved()`

4.3.3 Control API

Control API is used for controlling the functioning of MPEG2 Decoder during run-time. This is done by changing the status of the controllable parameters of the decoder during run-time. These controllable parameters are defined in the `IVIDDEC3_DynamicParams` data structure (see Data Structures section for details).

|| Name

`control()` – change run-time parameters of the MPEG2 Decoder and query the decoder status

|| Synopsis

```
XDAS_Int32 (*control)(IVIDDEC3_Handle handle, IVIDDEC3_Cmd
id,IVIDDEC3_DynamicParams *params, IVIDDEC3_Status
*status);
```

|| Arguments

```
IVIDDEC3_Handle handle; /* handle to the MPEG2 decoder
instance */
```

```
IVIDDEC3_Cmd id; /* MPEG2 decoder specific control
commands*/
```

```
IVIDDEC3_DynamicParams *params /* MPEG2 decoder run-time
parameters */
```

```
IVIDDEC3_Status *status /* MPEG2 decoder instance status
parameters */
```

|| Return Value

```
IALG_EOK; /* status indicating success */
```

```
IALG_EFAIL; /* status indicating failure */
```

|| Description

This function changes the run-time parameters of MPEG2 Decoder and queries the status of decoder. `control()` must only be called after a successful call to `algInit()` and must never be called after a call to `algFree()`.

The first argument to `control()` is a handle to the MPEG2 Decoder instance object.

The second argument is a command ID. See `IVIDDEC3_Cmd` in enumeration table for details.

The third and fourth arguments are pointers to the `IVIDDEC3_DynamicParams` and `IVIDDEC3_Status` data structures respectively.

Note:

If you are using extended data structures, the third argument must be a pointer to the extended `DynamicParams` data structure. Also, ensure that the `size` field is set to the size of the extended data structure. Depending on the value set for the `size` field, the algorithm uses either base or extended parameters.

|| See Also

`algInit()`

4.3.4 Data Processing API

Data processing API is used for processing the input data using the MPEG2 Decoder.

|| Name

|| Synopsis

`algActivate()` – initialize scratch memory buffers prior to processing.

|| Arguments

`Void algActivate(IALG_Handle handle);`

|| Return Value

`IALG_Handle handle; /* algorithm instance handle */`

|| Description

`Void`

`algActivate()` initializes any of the instance's scratch buffers using the persistent memory that is part of the algorithm's instance object.

The first (and only) argument to `algActivate()` is an algorithm instance handle. This handle is used by the algorithm to identify various buffers that must be initialized prior to calling any of the algorithm's processing methods.

For more details, see *TMS320 DSP Algorithm Standard API Reference*. (literature number SPRU360).

|| See Also

`algDeactivate()`

|| Name

`process()` – basic video decoding call

|| Synopsis

```
XDAS_Int32 (*process)(IVIDDEC3_Handle handle, XDM2_BufDesc
*inBufs, XDM2_BufDesc *outBufs, IVIDDEC3_InArgs *inargs,
IVIDDEC3_OutArgs *outargs);
```

|| Arguments

```
IVIDDEC3_Handle handle; /* handle to the MPEG2 decoder
instance */
```

```
XDM2_BufDesc *inBufs; /* pointer to input buffer descriptor
data structure */
```

```
XDM2_BufDesc *outBufs; /* pointer to output buffer
descriptor data structure */
```

```
IVIDDEC3_InArgs *inargs /* pointer to the MPEG2 decoder
runtime input arguments data structure */
```

```
IVIDDEC3_OutArgs *outargs /* pointer to the MPEG2 decoder
runtime output arguments data structure */
```

|| Return Value

```
IALG_EOK; /* status indicating success */
```

```
IALG_EFAIL; /* status indicating failure */
```

|| Description

This function does the basic MPEG2 video decoding. The first argument to `process()` is a handle to the MPEG2 Decoder instance object.

The second and third arguments are pointers to the input and output buffer descriptor data structures respectively (see `XDM1_BufDesc` and `XDM2_BufDesc` data structure for details).

The fourth argument is a pointer to the `IVIDDEC3_InArgs` data structure that defines the run-time input arguments for the MPEG2 Decoder instance object.

Note:

Prior to each decode call, ensure that all fields are set as described in `XDM2_BufDesc` and `IVIDDEC3_InArgs` structures.

The last argument is a pointer to the `IVIDDEC3_OutArgs` data structure that defines the run-time output arguments for the MPEG2 Decoder instance object.

The algorithm may also modify the output buffer pointers. The return value is `IALG_EOK` for success or `IALG_EFAIL` in case of failure. The `extendedError` field of the `IVIDDEC3_Status` structure contains error conditions flagged by the algorithm. This structure can be populated by calling Control API using `XDM_GETSTATUS` command.

Note:

If you are using extended data structures, the fourth argument must be a pointer to the extended `InArgs` data structure respectively. Also, ensure that the `size` field is set to the size of the extended data structure. Depending on the value set for the `size` field, the algorithm uses either base or extended parameters.

|| See Also

`control()`

|| Name

`algDeactivate()` – save all persistent data to non-scratch memory

|| Synopsis

```
Void algDeactivate(IALG_Handle handle);
```

|| Arguments

```
IALG_Handle handle; /* algorithm instance handle */
```

|| Return Value

```
Void
```

|| Description

`algDeactivate()` saves any persistent information to non-scratch buffers using the persistent memory that is part of the algorithm's instance object.

The first (and only) argument to `algDeactivate()` is an algorithm instance handle. This handle is used by the algorithm to identify various buffers that must be saved prior to next cycle of `algActivate()` and processing.

For more details, see TMS320 DSP Algorithm Standard API Reference.

|| See Also

```
algActivate()
```

4.3.5 Termination API

Termination API is used to terminate the MPEG2 Decoder and free up the memory space that it uses.

|| Name

`algFree()` – determine the addresses of all memory buffers used by the algorithm

|| Synopsis

```
XDAS_Int32 algFree(IALG_Handle handle, IALG_MemRec memTab[]);
```

|| Arguments

```
IALG_Handle handle; /* handle to the algorithm instance */  
IALG_MemRec memTab[]; /* output array of memory records */
```

|| Return Value

```
XDAS_Int32; /* Number of buffers used by the algorithm */
```

|| Description

`algFree()` determines the addresses of all memory buffers used by the algorithm. The primary aim of doing so is to free up these memory regions after closing an instance of the algorithm.

The first argument to `algFree()` is a handle to the algorithm instance.

The second argument is a table of memory records that describe the base address, size, alignment, type, and memory space of all buffers previously allocated for the algorithm instance.

For more details, see *TMS320 DSP Algorithm Standard API Reference* (literature number SPRU360).

|| See Also

`algAlloc()`

Frequently Asked Questions

This section answers frequently asked questions related to using MPEG-2 Main Profile Decoder on HDVICP2 and Media Controller Based Platform.

5.1 Code Build and Execution

Question	Answer
Build error saying that code memory section is not sufficient	Make sure that project settings are not changed from the released package settings such as making project settings as File -O0 and full symbolic debug which throws an error that code memory section is not sufficient.
Application returns an error saying "Couldn't open parameter file" while running the host test app	Make sure that input file path is given correctly. If the application is accessing input from network, ensure that the network connectivity is stable.

5.2 Issues with Tools Version

Question	Answer
Which tools are required to run the stand-alone codec?	To run the codec on stand-alone setup, you need Framework Components, Code Composer Studio, ARM compiler tools (CG tools). If you are running on the simulator, then the correct version of the HDVICP2 Simulation CSP is needed (See Section 2.1 for more details).
What CG tools version should I use for code compilation?	You may use CG tools version 4.5.1 to compile the code.

5.3 Algorithm Related

Question	Answer
Which XDM interface does codec support?	Codec supports XDM IVIDDEC3 interface.
Does MPEG-2 Decoder support non-multiple of 16 frame dimensions?	Yes, this decoder supports non-multiple of 16 image dimensions. Even odd resolutions are supported in this version.
Does this MPEG-2 Decoder support MPEG-1 constrained video streams?	Yes.
Which profiles and levels are supported by this decoder?	This decoder supports Simple Profile upto Main level and Main Profile upto High level.

Question	Answer
Does this decoder support decoding of interlaced video?	Yes.
Does this decoder support "decode header only" feature?	Yes.
Does this version of decoder have support for error concealment?	Yes. This version of decoder has support for error concealment (both spatial and temporal).
What are the maximum and minimum resolutions supported by the decoder?	This decoder supports resolutions ranging from 64x64 to 2048x2048.
Does this version of decoder support display delay?	Only display delay of 1 or 0 frames is supported in this release. Display delay 0 means decoding order.
Does Algorithm support DataSync mechanism?	No. This decoder does not support DataSync mechanism for either input or output buffers.
Does this decoder support return of MB Info and Error Info to enable transcode applications?	Yes.
Does the decoder support meta data output?	No. The decoder does not support returning metadata parsed from the bitstream (except the MBIInfo and error info for transcoding, as stated in answer to previous FAQ).
Does the decoder support out-of-loop deblocking?	Yes. The decoder supports optional out-of-loop deblocking for display.
What is the 128 byte alignment requirement for output buffers?	<p>In case the output buffer is in TILED region, the decoder requires a luma buffer of size $((\text{Width aligned to } 16) + 2) * ((\text{Height aligned to } 16) + 2)$ and a chroma buffer of size $((\text{Width aligned to } 16) + 2) * ((\text{Height}/2 \text{ aligned to } 16) + 2)$. In this case, there is no requirement for a 128 byte aligned picture/output buffer width. Decoder will use the corresponding TILED region pitch as the image pitch.</p> <p>In case the output buffer is in non-TILED region, the decoder requires a picture/output buffer with 128 byte aligned width. Thus the buffer requirements will be $128_byte_aligned(((\text{Width aligned to } 16) + 2) * ((\text{Height aligned to } 16) + 2))$ for luma buffer and $128_byte_aligned(((\text{Width aligned to } 16) + 2) * ((\text{Height}/2 \text{ aligned to } 16) + 2))$ for chroma buffer</p> <p>Please note that the decoder does not assume a 128 byte aligned picture buffer width, so the application has to inform the same using displayWidth feature supported by decoder. Then decoder will use this as image pitch.</p>

Picture Format

This Appendix explains picture format details for MPEG2 decoder. Decoder outputs YUV frames in NV 12 format.

6.1 NV12 Chroma Format

NV12 is YUV 420 semi-planar with two separate planes, one for Y, one for U and V interleaved.

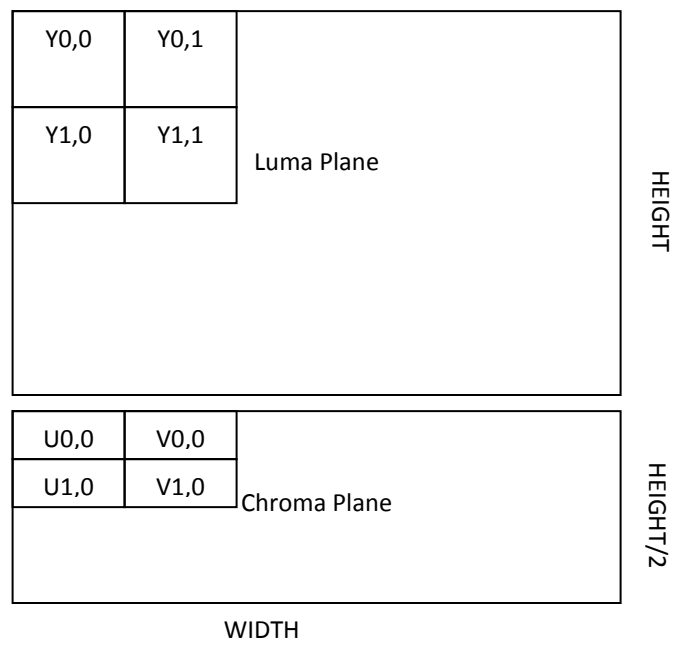

6.2 Progressive Picture Format

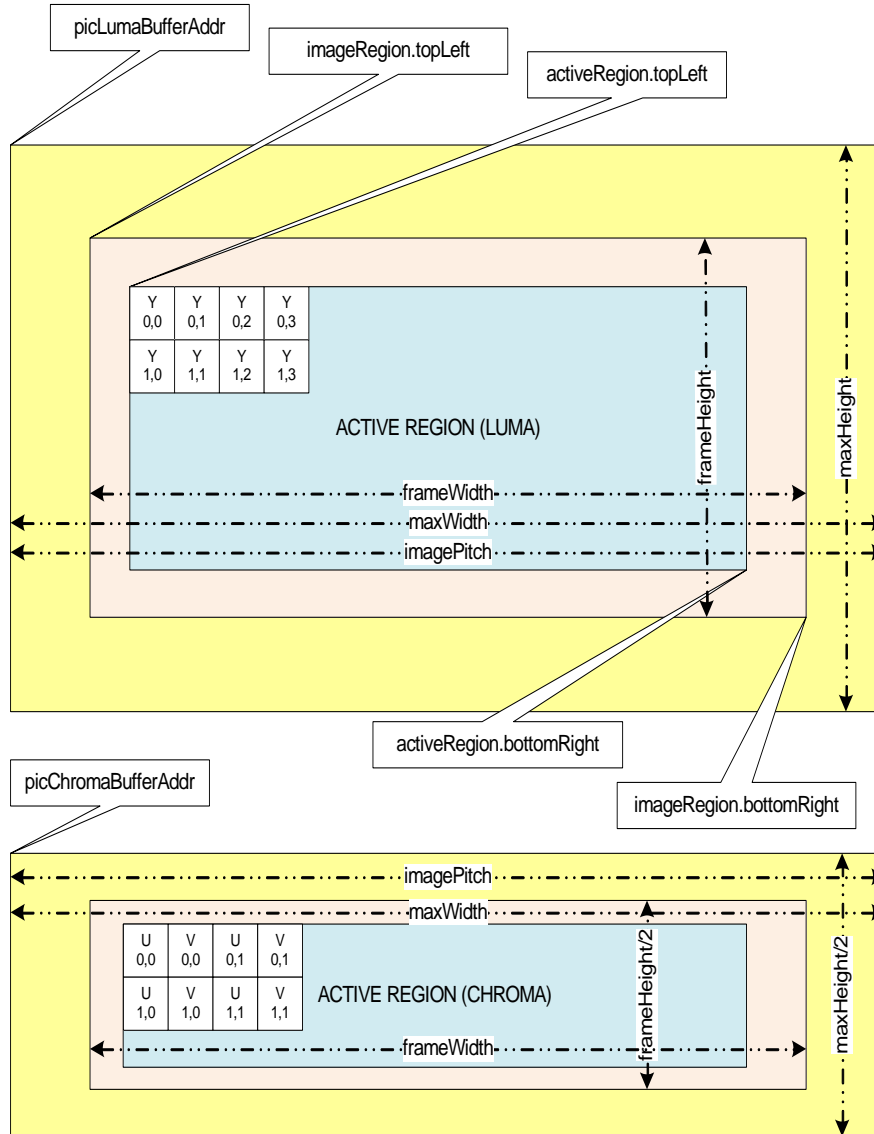

ActiveRegion and ImageRegion offsets for chroma are derived from luma offset
 $\text{ChromaXoffset} = \text{lumaX_offset} \& 0\text{ffffffe}$;
 $\text{ChromaYoffset} = (\text{lumaY_offset} \gg 1) \& 0\text{ffffffe}$;

Note that for decoder in case of progressive sequence:

- Luma and chroma buffer addresses can be allocated independently
- Application shall provide this through separate buffer addresses
- The outermost yellow coloured region is the minimum buffer that application should allocate for a given *maxWidth* and *maxHeight*
- *activeRegion*
 - The displayable region
- *imageRegion*
 - Image data decoded by the decoder whose dimensions are always multiple of 16.
 - Contains the activeRegion as a proper subset.
- *Picture Buffer (pic(Luma/Chroma)BufferAddr)*
 - Contains some extra region due to alignment and other constraints.
 - The dimensions (width, height, size) of this buffer should be queried from codec through GETBUFINFO control call
 - Contains the imageRegion as a proper subset.
- *imagePitch*
 - The difference in addresses of two vertically adjacent pixels
 - Typically equal to width of the picture Buffer.
- *Padding Amounts*
 - In vertical direction (bottom), padding amount is 2 pixels for both Luma buffer and chroma buffer.
 - In horizontal direction (right), padding amount is 2 pixels for both Luma buffer chroma buffer.

6.3 Interlaced Picture Format

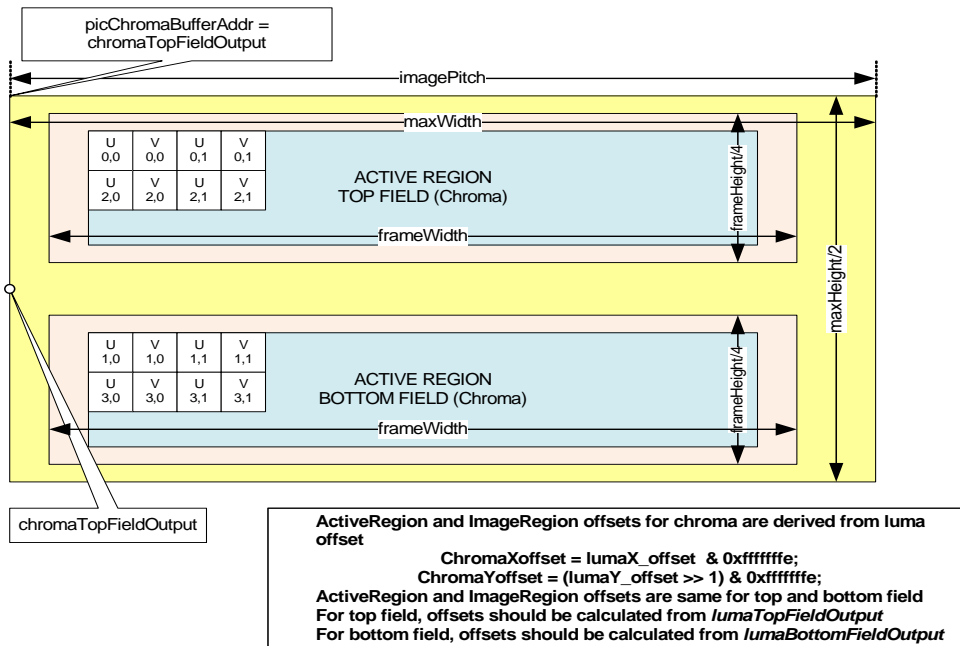
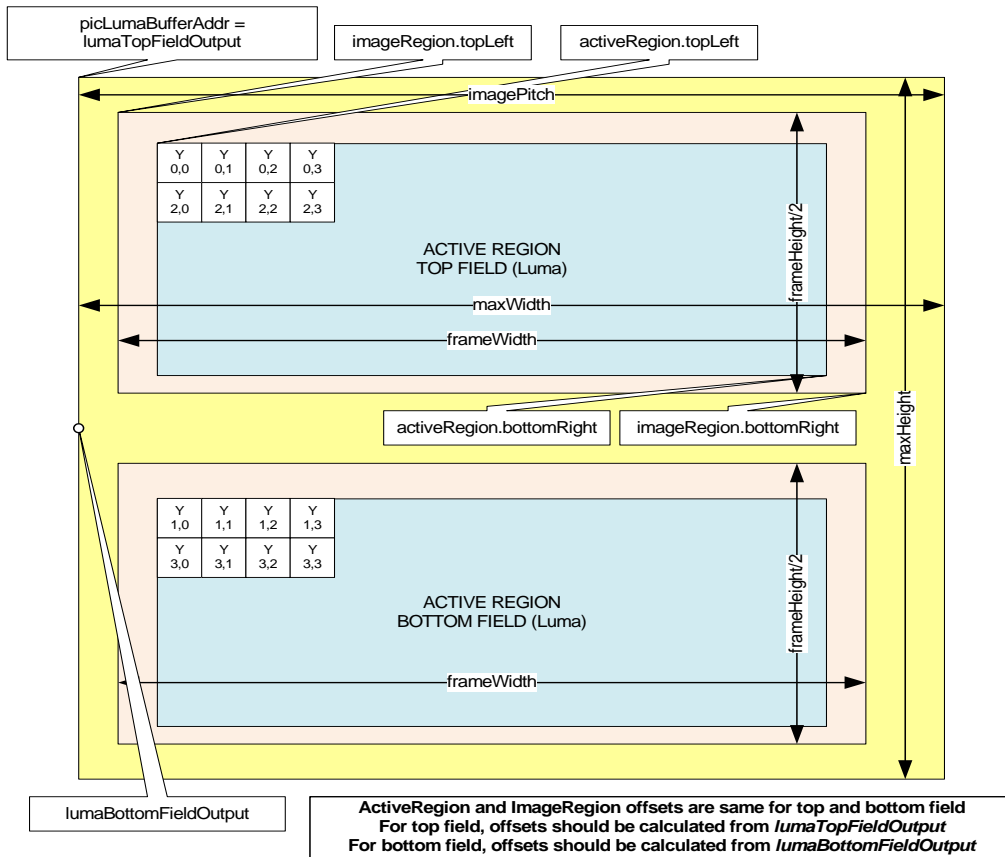

Note that for decoder in case of interlaced sequence:

- Luma and chroma buffers can be allocated independently
- Field buffer allocation cannot be independent
- For every pair of top and bottom field, decoder shall expect a single buffer address from the application
- The outermost yellow coloured region is the minimum buffer that application should allocate for a given *maxWidth* and *maxHeight*
- *activeRegion*
 - The displayable region
- *imageRegion*
 - Image data decoded by the decoder.
 - Contains the activeRegion as a proper subset.
- *Picture Buffer (pic(Luma/Chroma)BufferAddr)*
 - Contains some extra region due to alignment and other constraints.
 - The dimensions (width, height, size) of this buffer should be queried from codec through GETBUFINFO control call
 - Contains the imageRegion as a proper subset.
- *imagePitch*
 - The difference in addresses of two vertically adjacent pixels
 - Typically equal to width of the picture Buffer.
- *Padding Amounts*
 - In vertical direction (bottom), padding amount is 2 pixels for both Luma buffer and chroma buffer.
 - In horizontal direction (right), padding amount is 2 pixels for both Luma buffer chroma buffer.

6.4 Constraints on Buffer Allocation for Decoder

- *maxWidth* and *maxHeight* are inputs given to the decoder by the applications
 - Application may not know the output format of the decoder.
 - Therefore, application should allocate Image Buffer based on *maxWidth* and *maxHeight*
 - The extra region beyond the (*maxWidth* x *maxHeight*) requirements may be allocated by application due to alignment, pitch or some other constraints
- Application needs to ensure following conditions regarding *imagePitch*
 - *imagePitch* shall be greater or equal to the *maxWidth*.
 - *imagePitch* shall be multiple of 128 bytes (if the buffer is not in TILED region).
 - *imagePitch* shall actually be the tiler space width (i.e. depends on how many bit per pixel, for 8bpp 16bpp and 32bpp respectively 16Kbyte, 32Kbyte and 32Kbyte). (if the buffer is in TILED region).
 - Application may set *imagePitch* greater than *maxWidth* as per display constraints. However this value must be a multiple of 128 bytes (if the buffer is not in TILED region).
- *picLumaBufferAddr* and *picChromaBufferAddr* shall be 16-byte aligned address. (if the buffer is not in TILED region).
- *ActiveRegion.topLeft* and *ActiveRegion.bottomRight* are decoder outputs
 - Application should calculate actual display width and display height based on these parameters
 - *ActiveRegion.topLeft* and *ActiveRegion.bottomRight* shall be identical for both fields in case of interlaced format
- Maximum and Minimum Resolution is defined as below
 - Progressive
 - Minimum *frameWidth* = 64
 - Minimum *frameHeight* = 64
 - Maximum *frameWidth* = 2048
 - Maximum *frameHeight* = 2048
 - Interlaced
 - Minimum *frameWidth* = 64
 - Minimum (*frameHeight* / 2) = 32
 - Maximum *frameWidth* = 2048
 - Maximum (*frameHeight* / 2) = 1024
- Typically picture buffer allocation requirements for decoder, after buffer addresses meet alignment constraints and other requirements, for both progressive and interlaced are as given below.

- Luma buffer size = $\text{maxWidth} \times \text{maxHeight}$ and
Chroma buffer size = $\text{maxWidth} \times \text{maxHeight}/2$ where
 - $\text{maxWidth} = \text{frameWidth} + 2$ (additional 2 columns for reference buffer fetch optimization)
 - $\text{maxHeight} = \text{frameHeight} + 2$ (additional 2 rows for reference buffer fetch optimization)

This page is intentionally left blank

Debug Trace Usage

This section describes the debug trace feature supported by codec and its usage.

7.1 Introduction

This section explains the approach and overall design that will be adopted for enabling a trace from a video codec.

The primary uses of Debug Trace are:

- 1) Make the codec implementation capable of producing a trace containing details about the history of executing a particular instance of the codec
- 2) Enable the application to dump certain debug parameters from the codec in case of a failure. A failure might even be a hang or crash but in general can be defined as any unacceptable or erroneous behavior

Such a feature is targeted at providing more visibility into the operation of the codec and thus easing and potentially accelerating the process of debug.

7.2 Enabling and using debug information

To enable debug information, following two parameters are added to the create time parameters

- 1) debugTraceLevel
- 2) lastNFramesToLog

Hence the MPEG-2 decoder create time parameters are modified as

```
typedef struct IMPEG2VDEC_Params{
    VIDDEC3_Params viddecParams;
    XDAS_Int32    ErrorConcealmentON;
    XDAS_UInt32  outloopDeBlocking;
    XDAS_UInt32  debugTraceLevel;
    XDAS_UInt32  lastNFramesToLog;
} IMPEG2VDEC_Params;
```

7.2.1 *debugTracelevel*

This parameter configures the codec to dump a debug trace log

- ❑ 0: Disables dumping of debug trace parameters
- ❑ >0: Enables the dumping of debug trace parameters. Value specifies the level of debug trace information

7.2.2 *lastNFramesToLog*

This parameter configures the codec to maintain history of debug trace parameters for last N frames.

- ❑ 0: No history will be maintained by the codec
- ❑ >0 : History of past specified number of frames will be maintained

In order to avoid book-keeping by the application to know whether the codec has been configured to dump debug trace and where the debug information is available, the following changes are done in the Status structure.

```
typedef struct IMPEG2VDEC_Status{  
    IVIDDEC3_Status viddecStatus;  
    XDAS_UInt32 extendedErrorCode0;  
    XDAS_UInt32 extendedErrorCode1;  
    XDAS_UInt32 extendedErrorCode2;  
    XDAS_UInt32 extendedErrorCode3;  
    XDAS_UInt32 debugTraceLevel;  
    XDAS_UInt32 lastNFramesToLog;  
    XDAS_UInt32 * extMemoryDebugTraceAddr;  
    XDAS_UInt32 extMemoryDebugTraceSize;  
} IMPEG2VDEC_Status
```

debugTraceLevel: Debug trace level configured for the codec - 0, 1, 2,3,4

lastNFramesToLog: Number of frames for which history information is maintained by the codec

extMemoryDebugTraceAddr: External memory address (as seen by Media Controller) where debug trace information is being dumped – last memory buffer requested by the codec

extMemoryDebugTraceSize: External memory buffer size (in bytes) where debug trace information is being dumped - the size of last memory buffer

Now the application can retrieve this information from the codec at any time by the existing GETSTATUS query through the codec's Control API.

7.3 Debug Trace Levels

Debug Debug trace has been (in this implementation) organized into 4 different levels arranged in a hierarchical fashion.

- ❑ Level 1 – Frame level information and profile data
- ❑ Level 2 – Slice and MB level information
- ❑ Level 3 – Logs function call stack for with entry hook
- ❑ Level 4 – Logs function call stack for with exit hook

At each higher level, the previous lower levels are also enabled

7.4 Requirements On The Application

The following are the requirements on the application side:

1. The application should be capable of configuring *debugTraceLevel* and *lastNFrameToLog* which are part of the Initialization Parameters of the codec
2. The application should be capable of querying the codec for its debug parameter memory regions and size
3. The application should be capable of retrieving these memory regions (In external memory or SL2) for the specified size and preserving these memory dumps in case of any erroneous behavior including a hang/crash.
4. The application, at any time (in case of hang, crash or any unexpected behavior) is expected to be also capable of retrieving the SL2 memory region as returned by the codec in Control-GETSTATUS specified by the SL2 memory debug trace address and size and provide it to the codec developer. The codec developer will have a PC based tool to parse and interpret this dump and produce a readable log of the debug trace parameters.

This page is intentionally left blank

Error Concealment Usage

This section describes the error concealment feature supported by codec and its usage.

8.1 Introduction

When a corrupted input stream is provided to video codec, the codec will decode the stream until the error occurs and comes out of process call gracefully. In this case, the output might have visual artifacts. The amount of artifacts depends on the error type and the amount of valid data before the error occurrence.

Error concealment feature, when enabled will apply concealment algorithms on the improper output and will reduce the amount of distortion in output.

8.2 Enabling and using Error concealment

To enable error concealment, following parameter is added to the create time parameters.

- `ErrorConcealmentON`

Hence the MPEG-2 decoder create time parameters are modified as

```
typedef struct IMPEG2VDEC_Params{
    IVIDDEC3_Params viddecParams;
    XDAS_Int32 ErrorConcealmentON;
    XDAS_UInt32 outloopDeBlocking;
    XDAS_UInt32 debugTraceLevel;
    XDAS_UInt32 lastNFramesToLog;
} IMPEG2VDEC_Params;
```

Apart from setting the `ErrorConcealmentON` parameter, user has to enable `TRANSCODE` mode of operation, set the `metadataType` and provide an additional metadata buffer for using error concealment feature of MPEG-2 decoder. The same is explained in the following sections.

8.2.1 ErrorConcealmentON

This parameter configures the codec to enabled/disable error concealment.

- ❑ 0: Disables concealment
- ❑ 1: Enables concealment

8.2.2 Transcode Mode

User has to enable transcode mode of operation to use the concealment feature. This can be achieved by setting the 'operatingMode' parameter of IVIDDEC3_Params to 'IVIDEO_TRANSCODE_FRAMELEVEL'.

8.2.3 MetaData Type

User has to provide the Metadata type to codec to use concealment feature. This can be achieved by setting the 'metadataType' parameter of IVIDDEC3_Params to IVIDEO_METADATAPLANE_MBINFO.

8.3 MetaData Buffer Requirement

Once the user sets the codec to work in TRANSCODE mode of operation and metadataType during create time, the codec will request for an additional buffer when the application queries for buffer requirement through GETBUFINFO.

The following table compares the codec buffer requirements with and w/o error concealment.

Buffer	Properties	w/o Error concealment	With Error concealment
Number of Input buffers required		1	1
Inputbuffer	Bit stream	Yes	Yes
Number of output buffers required		2	3
Outputbuffer[0]	Luma buffer	Yes	Yes
Outputbuffer[1]	Chroma buffer	Yes	Yes
Outputbuffer[2]	Meta data buffer	No	Yes

Please note that 'Yes' indicates that the corresponding buffer is required and 'No' indicates that the buffer is not required for decoding to work properly.

The required size of the metadata buffer can be calculated from below equation.

```
frameSize = (ROUND_TO_NEXT_MULT16(maxWidth) *  
            ROUND_TO_NEXT_MULT16(maxHeight))
```

No of MBs in frame = (frameSize) >> 8;

Size of the buffer = No of MBs in frame * 112 + frameSize

The metadata buffer should be a non-TILED buffer.

Following snippet of code explains the example buffer allocation (Refer to sample test application provided).

```
if((MetaDataType == IVIDEO_METADATAPLANE_MBINFO) || (ErrorConcealmentON))  
{  
    outputBufDesc.numBufs      = 3;  
    outputBufDesc.descs[2].bufSize.bytes =  
    (XDAS_Int32) buffEle->bufSize[2].bytes;  
    outputBufDesc.descs[2].buf      = (XDAS_Int8 *) buffEle->buf[2];  
    outputBufDesc.descs[2].memType  = XDM_MEMTYPE_ROW;  
    outputBufDesc.descs[1].accessMask = XDM_ACCESSMODE_READ;  
}
```

Codec return the buffer through outArgs->decodebufs->metadataPlaneDesc[0].buf.

8.4 Requirements On The Application

The following are the requirements on the application side:

1. The application should be capable of configuring `ErrorconcealmentON`, `operatingMode` and `metadataType` which are part of the Initialization Parameters of the codec.
2. The application should be capable of querying the codec for its memory regions and size using `GETBUFINFO`.
3. The application should be capable of providing the additional required buffer to codec through process call through `outBufsdesc`.

This page is intentionally left blank

Error Handling

This section explains the error handling by MPEG-2 Decoder.

9.1 Description

This version of the decoder supports handling of erroneous situations while decoding. If decoder encounters any erroneous situations, it shall exit gracefully without any hang or crash. Also, decoder process call shall return `IVIDDEC3_EFAIL` and relevant error code will be populated in `extendedError` field of `outArgs`.

Some of the erroneous situations will get reported as `XDM_FATALERROR` by the decoder. In certain fatal erroneous situations, the application might flush out the locked buffers, if need be.

Meanings of various error codes and the recommended application behavior are provided in the following tables:

Table 9-1 Error Codes used to set the `extendedError` field in `IVIDDEC3_OutArgs` and `IVIDDEC3_Status`

Bit	Error Code	Explanation	Recommended App Behaviour
0	<code>IMPEG2VDEC_ERR_UNSUPPORTED_VIDD EC3PARAMS</code>	This error code has been deprecated.	NA
1	<code>IMPEG2VDEC_ERR_UNSUPPORTED_VIDD EC3DYNAMICPARAMS</code>	Base class Dynamic params out of supported range	Call <code>GETSTATUS</code> by passing extended Status structure to get more details about the error through <code>extendedErrorCode0 (/1/2/3)</code> parameters
2	<code>IMPEG2VDEC_ERR_UNSUPPORTED_MPEG 2DECDYNAMICPARAMS</code>	Extended class Dynamic params out of supported range	Call <code>GETSTATUS</code> by passing extended Status structure to get more details about the error through <code>extendedErrorCode0 (/1/2/3)</code> parameters
3	<code>IMPEG2VDEC_ERR_IMPROPER_DATASYN C_SETTING</code>	This error code has been deprecated.	NA
4	<code>IMPEG2VDEC_ERR_NOSLICE</code>	Illegal start code search error from ECD	The input stream might be corrupted. Pass the next frame in the stream.
5	<code>IMPEG2VDEC_ERR_SLICEHDR</code>	Illegal Slice start/End error from ECD	The input stream might be corrupted. Pass the next frame in the stream.
6	<code>IMPEG2VDEC_ERR_MBDATA</code>	Data error detected by ECD	The input stream might be corrupted. Pass the next frame in the stream.
7	<code>IMPEG2VDEC_ERR_UNSUPPFEATURE</code>	Unsupported header extensions and profile/levels	Call <code>GETSTATUS</code> by passing extended Status structure to get more details about the error through <code>extendedErrorCode0</code>

			(/1/2/3) parameters. Refer Section 1.3 of this user guide for supported services and features.
16	IMPEG2VDEC_ERR_STREAM_END	End of stream Detected while parsing	Pass the next frame in the stream.
17	IMPEG2VDEC_ERR_UNSUPPRESOLUTION	Stream resolution out of create time range	Call delete and create again with proper resolutions
18	IMPEG2VDEC_ERR_STANDBY	HDVICP2 not in standby on acquire	Do HDVICP_Reset, XDM Reset and pass stream
19	IMPEG2VDEC_ERR_INVALID_MBOX_MESSAGE	Message from iCont to host not defined	Do HDVICP_Reset, XDM Reset and pass stream
20	IMPEG2VDEC_ERR_HDVICP_RESET	HDVICP2 reset API from host to RMAN failed	Do XDM Reset and pass stream
21	IMPEG2VDEC_ERR_HDVICP_WAIT_NOT_CLEAN_EXIT	Erroneous exit from the wait API from host to RMAN	Pass the next frame in the stream
22	IMPEG2VDEC_ERR_SEQHDR	Invalid values of the parameters in sequence header	Pass the next frame in the stream. Decoding will not be proper till the next proper sequence header is encountered.
23	IMPEG2VDEC_ERR_GOP_PICHDR	Invalid values of the parameters in GOP and picture headers	Pass the next frame in the stream
24	IMPEG2VDEC_ERR_SEQLVL_EXTN	Invalid values of the parameters in sequence level extension headers	Pass the next frame in the stream. Decoding will not be proper till the next proper sequence header is encountered.
25	IMPEG2VDEC_ERR_PICLVL_EXTN	Invalid values of the parameters in picture level extension headers	Pass the next frame in the stream
26	IMPEG2VDEC_ERR_TRICK_MODE	Denotes frame skipped/ reference frame skipped in Trick mode and reference frames are not available for P-Frames and B-Frames .	Pass the next frame in the stream
27	IMPEG2VDEC_ERR_PICSIZECHANGE	Change in frame dimensions in repeat sequence header	Pass the next frame in the stream
28	IMPEG2VDEC_ERR_SEMANTIC	Semantic rules of a MPEG-2 stream not followed	Pass the next frame in the stream
29	IMPEG2VDEC_ERR_DECODE_EXIT	Decoder failed to consume all the input bytes / All MBs not decoded. This has been added to detect the corruption of dimension parameters in header.	Pass the next frame in the stream
30	IMPEG2VDEC_ERR_IRES_RESHANDLE	Invalid resource handle in IRES interface	Call delete and create again with proper handle
31	IMPEG2VDEC_ERR_IRES_RESDESC	This error code has been deprecated.	NA

Table 9-2 Error Codes used to set the extendedErrorCode0 ,extendedErrorCode1, extendedErrorCode2 and extendedErrorCode3 fields in IMPEG2VDEC_Status

Bit	Error Code	Explanation	Recommended App Behaviour
0	MPEG2_ECD_ILLEGAL_EOM	ECD3 cannot find EOM, end of macroblock, at the end of macroblock when picture_type is D-picture	The input stream might be corrupted. Pass the next frame in the stream.
1	MPEG2_ECD_ILLEGAL_EOB	ECD3 cannot find EOB, end of block, in a 64 coefficient block	The input stream might be corrupted. Pass the next frame in the stream.
2	MPEG2_ECD_ILLEGAL_MP1_ESCAPE_LVL	Decoded level from MPEG-2 ESCAPE code is 0x000 or 0x800	The input stream might be corrupted. Pass the next frame in the stream.
3	MPEG2_ECD_ILLEGAL_MP2_ESCAPE_LVL	Decoded level from MPEG-1 ESCAPE code is 0x0000 or 0x8000	The input stream might be corrupted. Pass the next frame in the stream.
4	MPEG2_ECD_ILLEGAL_MARKER_CONCEAL	Invalid parameter value in data	The input stream might be corrupted. Pass the next frame in the stream.
5	MPEG2_ECD_ILLEGAL_MBTYPE_D_PIC	Invalid parameter value in data	The input stream might be corrupted. Pass the next frame in the stream.
6	MPEG2_ECD_ILLEGAL_DCT_COEFF	Invalid parameter value in data	The input stream might be corrupted. Pass the next frame in the stream.
7	MPEG2_ECD_ILLEGAL_CBP	Invalid parameter value in data	The input stream might be corrupted. Pass the next frame in the stream.
8	MPEG2_ECD_ILLEGAL_MOTION_CODE	Invalid parameter value in data	The input stream might be corrupted. Pass the next frame in the stream.
9	MPEG2_ECD_ILLEGAL_MB_TYPE	Invalid parameter value in data	The input stream might be corrupted. Pass the next frame in the stream.
10	MPEG2_ECD_ILLEGAL_MB_ADDR_INCR	Invalid parameter value in data	The input stream might be corrupted. Pass the next frame in the stream.
11	MPEG2_ECD_ILLEGAL_EOS	End of slice cannot be found at the end of picture	The input stream might be corrupted. Pass the next frame in the stream.
12	MPEG2_ECD_ILLEGAL_QUANT_SCALE_CODE	Decoded quantizer_scale_code is zero	The input stream might be corrupted. Pass the next frame in the stream.
13	MPEG2_ECD_ILLEGAL_SLICE_START_POS	Showing that two data is mismatched. ECD3 uses macroblock position in ECD3 ON registers and continue processing.	The input stream might be corrupted. Pass the next frame in the stream.
14	MPEG2_ECD_ILLEGAL_START_CODE_SEARCH	Showing next start code searching infinite error	The input stream might be corrupted. Pass the next frame in the stream.

16	MPEG2_ECD_ILLEGAL_DC_COEFF_OVF L	Result of DC prediction is overflow or underflow	The input stream might be corrupted. Pass the next frame in the stream.
17	MPEG2_DYNAMIC_PARAMS_HANDLE_ER ROR	Dynamic parameters handle NULL	Call SETPARAMS with proper dynamicParams
18	MPEG2_STATUS_HANDLE_ERROR	This error code has been deprecated.	NA
19	MPEG2_DYNAMIC_PARAMS_SIZE_ERRO R	Dynamic params size neither base class or extended class size	Call SETPARAMS with proper values
20	MPEG2_STATUS_SIZE_ERROR	This error code has been deprecated.	NA
21	MPEG2_DECODE_HEADER_ERROR	DynamicParams.decodeHeader value out of supported range	Call SETPARAMS with proper values
22	MPEG2_DISPLAY_WIDTH_ERROR	DynamicParams.displayWidth value out of supported range	Call SETPARAMS with proper values
23	MPEG2_FRAME_SKIP_MODE_ERROR	DynamicParams.frameSkipMode value out of supported range	Call SETPARAMS with proper values
24	MPEG2_NEW_FRAME_FLAG_ERROR	DynamicParams.newFrameFlag value out of supported range	Call SETPARAMS with proper values
25	MPEG2_GOTO_IFRAME_ERROR	Extended Dynamic param gotoNextIFrame out of supported range	Call SETPARAMS with proper values
26	MPEG2_SKIP_BFRAME_ERROR	Extended Dynamic param skipBFrame out of supported range	Call SETPARAMS with proper values
27	MPEG2_SKIP_CURRENTFRAME_ERROR	Extended Dynamic param skipCurrFrame out of supported range	Call SETPARAMS with proper values
28	MPEG2_SEEK_FRAMEEND_ERROR	Extended Dynamic param seekFrameEnd out of supported range	Call SETPARAMS with proper values
29	MPEG2_NULL_STATUS_DATA_BUF	Data Buffer pointer in status structure NULL in GETVERSION control call	Call GETVERSION with proper data buffer pointer in status structure
30	MPEG2_INSUFFICIENT_STATUS_DATA _BUF	Data buffers within status structure less than 96 bytes during getversion control call	Call GETVERSION with proper data buffer size
31	MPEG2_NULL_INARGS_POINTER_ERRO R	InArgs pointer in process call NULL	Call process call with valid inArgs pointer to process call
32	MPEG2_INARGS_SIZE_ERROR	InArgs size in process call neither base class size nor extended class size	Call process call with valid size for inArgs during process call
33	MPEG2_INVALID_INPUT_BYTES_ERRO R	Non-positive value of the input bytes(plnArgs->numBytes) to process call	Call process call with a valid input buffer size
34	MPEG2_INVALID_INPUT_ID_ERROR	The input ID of output buffer is 0	Call process call with a valid input ID
35	MPEG2_DECODER_NOT_INITIALIZED_ ERROR	This error code has been deprecated.	NA
36	MPEG2_NULL_INPUT_BUF_DESC_ERRO R	Pointer to the Input Buffer descriptor is NULL	Call process call with valid input buffer descriptor pointer to process call
37	MPEG2_NULL_INPUT_BUFFER_POINTE R_ERROR	Input buffer pointer is NULL	Call process call with valid input buffer pointer to process call
38	MPEG2_INVALID_INPUT_BUFFER_SIZ E_ERROR	Invalid Input buffer size: when non-positive values for bytes in raw and dimensions in tiler	Call process call with valid input buffer size to process call
39	MPEG2_INVALID_NUM_OF_INPUT_BUF FERS_ERROR	Insufficient buffers (when number of Input Buffers less than 1)	Call process call with sufficient number of input buffers to process call
40	MPEG2_EXCESS_NUM_OF_INPUT_BUFF ERS_ERROR	Redundant input buffers (greater than 1)	Pass the next frame in the stream with appropriate number of input buffers
41	MPEG2_INVALID_INPUT_BUFFER_MEM TYPE_ERROR	Input stream buffer memory type other than RAW/Page mode	Call process call with valid input buffer memory type to process call
42	MPEG2_NULL_OUTARGS_POINTER_ER ROR	OutArgs pointer is NULL	Call process call with valid outArgs pointer to process call
43	MPEG2_INVALID_OUTARGS_SIZE	OutArgs size set to value other than base class or extended class	Call process call with valid size for outArgs during process call

		size	
44	MPEG2_NULL_OUTPUT_BUF_DESC_POINTER_ERROR	The Display buffer descriptor pointer in OutArgs is NULL	Call process call with valid input buffer descriptor pointer to process call
45	MPEG2_NULL_OUTPUT_BUF_DESC_ERROR	The Output buffer descriptor pointer provided in process call is NULL	Call process call with valid output buffer descriptor pointer to process call
46	MPEG2_INVALID_OUTPUT_BUFFER0_POINTER_ERROR	Luma output buffer pointer is NULL	Call process call with valid luma output buffer pointer to process call
47	MPEG2_INVALID_OUTPUT_BUFFER0_SIZE_ERROR	Luma output buffer size/dimensions being non-positive	Call process call with valid luma output buffer size to process call
48	MPEG2_INVALID_NUM_OF_OUTPUT_BUFFERS_ERROR	Number of output buffers other than 2 (3 in metadataType Mbinfo)	Call process call with appropriate number of output buffers to process call
49	MPEG2_INVALID_OUTPUT_BUFFER0_MEMORYTYPE_ERROR	Luma buffer memory other than Raw, tiled8, and tiledpage mode	Call process call with valid luma output buffer memory type to process call
50	MPEG2_INVALID_OUTPUT_BUFFER0_ALIGNMENT_ERROR	Luma buffer base address not 128-bit aligned	Call process call with properly aligned luma output buffer to process call
51	MPEG2_INVALID_OUTPUT_BUFFER1_POINTER_ERROR	Chroma output buffer pointer is NULL	Call process call with valid chroma output buffer pointer to process call
52	MPEG2_INVALID_OUTPUT_BUFFER1_SIZE_ERROR	Chroma output buffer size/dimensions being non-positive	Call process call with valid chroma output buffer size to process call
53	MPEG2_INVALID_OUTPUT_BUFFER1_MEMORYTYPE_ERROR	Chroma buffer memory other than Raw, tiled 8, tiled16 and page mode	Call process call with valid chroma output buffer memory type to process call
54	MPEG2_INVALID_OUTPUT_BUFFER1_ALIGNMENT_ERROR	Chroma buffer base address not 128-bit aligned	Call process call with properly aligned chroma output buffer to process call
55	MPEG2_INVALID_OUTPUT_BUFFER2_POINTER_ERROR	MBinfo output buffer pointer is NULL in metadataType Mbinfo mode	Call process call with valid MBInfo output buffer pointer to process call
56	MPEG2_INVALID_OUTPUT_BUFFER2_SIZE_ERROR	MBinfo output buffer size is non-positive in metadataType Mbinfo mode	Call process call with valid MBInfo output buffer size to process call
57	MPEG2_INVALID_OUTPUT_BUFFER2_MEMORYTYPE_ERROR	MBinfo output buffer memory type other than RAW in metadataType Mbinfo mode	Call process call with valid MBInfo output buffer memory type to process call
58	MPEG2_INVALID_BUFFER_USAGE_MODE	This error code has been deprecated.	NA
59	MPEG2_SEQ_HDR_INVALID_FRAME_WIDTH	Frame width from header being 0 or greater than max width provided at create time	Pass the next frame in the stream
60	MPEG2_SEQ_HDR_INVALID_FRAME_HEIGHT	Frame height from header being 0 or greater than max height provided at create time	Pass the next frame in the stream
61	MPEG2_SEQ_HDR_INVALID_ASPECT_RATIO	Aspect ratio from sequence header is not standard compliant	Pass the next frame in the stream
62	MPEG2_SEQ_HDR_INVALID_FRAME_RATE_CODE	Frame rate code from sequence header not standard compliant	Pass the next frame in the stream
63	MPEG2_INVALID_INTRA_QUANT_MAT	Intra quantization matrix in sequence header or quantization matrix extension is not standard compliant	Pass the next frame in the stream
64	MPEG2_INVALID_NON_INTRA_QUANT_MAT	Non-Intra quantization matrix in sequence header or quantization matrix extension is not standard compliant	Pass the next frame in the stream
65	MPEG2_SEQ_HDR_INVALID_INTRA_ESCAPE_BIT	Escape bit in ProfileandLevel indication of sequence extension is not standard compliant	Pass the next frame in the stream
66	MPEG2_SEQ_HDR_INVALID_PROFILE	Unsupported Profile, other than simple and main	Pass the next frame in the stream
67	MPEG2_SEQ_HDR_INVALID_LEVEL	Invalid level indication in sequence extension	Pass the next frame in the stream
68	MPEG2_SEQ_HDR_INVALID_RESOLUTION_FORLVL	Level based resolution constraints violated	Pass the next frame in the stream

69	MPEG2_SEQ_HDR_INVALID_CHROMA_FORMAT	Chroma format in sequence extension other than 4:2:0	Pass the next frame in the stream
70	MPEG2_SEQ_HDR_INVALID_LOW_DELAY	Low-delay flag set to '1' in sequence extension not supported	Pass the next frame in the stream
71	MPEG2_SEQ_DSP_INVALID_VIDEO_FORMAT	Video format parameter in sequence display extension not standard compliant	Pass the next frame in the stream
72	MPEG2_SEQ_DSP_INVALID_COLOUR_PRIM	Colour primaries parameter in sequence display extension not standard compliant	Pass the next frame in the stream
73	MPEG2_SEQ_DSP_INVALID_TRF_CHARS	Transfer characteristics parameter in sequence display extension not standard compliant	Pass the next frame in the stream
74	MPEG2_SEQ_DSP_INVALID_MAT_COEFFS	Matrix coefficients for colour conversion in sequence display extension not standard compliant	Pass the next frame in the stream
75	MPEG2_GOP_HDR_INVALID_DROP_FLAG	The drop flag in GOP header set when frame rate is not 29.97 Hz	Pass the next frame in the stream
76	MPEG2_GOP_HDR_INVALID_HOUR	Invalid 'hour' parameter in GOP header	Pass the next frame in the stream
77	MPEG2_GOP_HDR_INVALID_MIN	Invalid 'minute' parameter in GOP header	Pass the next frame in the stream
78	MPEG2_GOP_HDR_INVALID_SEC	Invalid 'second' parameter in GOP header	Pass the next frame in the stream
79	MPEG2_GOP_HDR_INVALID_TIME_CODE_PICTURES	Invalid 'frame' parameter in GOP header	Pass the next frame in the stream
80	MPEG2_GOP_HDR_INVALID_BROKEN_LINK	Broken link in GOP header for a closed GOP	Pass the next frame in the stream
81	MPEG2_PIC_HDR_INVALID_TEMP_REF	This error code has been deprecated.	Pass the next frame in the stream
82	MPEG2_PIC_HDR_INVALID_PIC_TYPE	Invalid picture type code: D-picture in MPEG2 and B-picture in MPEG1 simple profile.	Pass the next frame in the stream
83	MPEG2_PIC_HDR_INVALID_VBV_DELAY	This error code has been deprecated.	Pass the next frame in the stream
84	MPEG1_PIC_HDR_INVALID_FWD_FCODE	Forward f-code in picture header for B/P pictures is '0'	Pass the next frame in the stream
85	MPEG1_PIC_HDR_INVALID_BWD_FCODE	Backward f-code in picture header for B pictures is '0'	Pass the next frame in the stream
86	MPEG2_PIC_HDR_INVALID_FCODE	Invalid fcode values in picture extension	Pass the next frame in the stream
87	MPEG2_PIC_HDR_INVALID_PIC_STRUCTURE	Invalid picture_structure value in picture extension. Also, progressive sequence has to contain 'frame' pictures.	Pass the next frame in the stream
88	MPEG2_PIC_HDR_INVALID_FIELD_COMB	Picture type combinations for filed pictures not standard compliant. Valid types: II, IP, PP, BB	Pass the next frame in the stream
89	MPEG2_PIC_HDR_INVALID_TFF	Top_field_first flag in picture coding extension not standard compliant	Pass the next frame in the stream
90	MPEG2_PIC_HDR_INVALID_FPF	framePredFrameDct flag in picture coding extension not standard compliant: has to be '1' for progressive sequence; has to be '0' for field pictures	Pass the next frame in the stream
91	MPEG2_PIC_HDR_INVALID_RFF	RepeatFirstField flag in picture coding extension had to be '0' for a progressive sequence	Pass the next frame in the stream
92	MPEG2_PIC_HDR_INVALID_PROG_FLAG	Picture structure has to be 'frame' in a progressive frame	Pass the next frame in the stream
93	MPEG2_QUANT_EXT_INVALID_LOAD_CHROMA_INTRA_FLAG	load_chroma_intra_quantizer_matrix shall be '0' for 4:2:0 format	Pass the next frame in the stream
94	MPEG2_QUANT_EXT_INVALID_LOAD_CHROMA_NON_INTRA_FLAG	load_chroma_non_intra_quantizer_matrix shall be '0' for 4:2:0 format	Pass the next frame in the stream
95	MPEG2_INVALID_EXTN_CODE	Undefined header extension code	Refer Section 1.3 of this user guide for supported services and features.

96	MPEG2_SEQ_HDR_MISSING	Picture header is encountered before sequence header	Pass the next frame in the stream
97	MPEG2_NO_PICTURE_ENCODED_ERROR	This error code has been deprecated.	NA
98	MPEG2_SEQ_EXT_MISSING	Occurrence of picture coding extension without sequence extension	Pass the next frame in the stream
99	MPEG2_PIC_CODING_EXT_MISSING	This error code has been deprecated.	NA
100	MPEG2_SEQ_DISP_EXT_MISSING	This error code has been deprecated.	NA
101	MPEG2_GOP_FIRST_FRAME_NOT_I	First picture of a GOP not an I picture	Pass the next frame in the stream
102	MPEG2_SCALABILITY_NOT_SUPPORTED	Scalable extensions not supported, hence just parsed	Pass the next frame in the stream
103	MPEG2_END_OF_SEQ_DETECTED	Sequence end code detected on parsing	End of sequence has been reached
104	MPEG2_PIC_HDR_RFF_FRAME_RATE_MISMATCH	Standard defined dependency of repeatFirstField flag on frame rate violated	Pass the next frame in the stream
105	MPEG2_PIC_HDR_INVALID_DC_PRECISION	intraDcPrecision decides the scaling factor in the inverse quantization process for the DC coefficient of an intra block. This has an invalid value.	Pass the next frame in the stream
106	MPEG2_INVALID_FRAME_RATE	Frame rate from header is '0' or greater than the max value set during create time	Pass the next frame in the stream
107	MPEG2_INVALID_BIT_RATE	Bit-rate from header is '0' or greater than the max value set during create time	Pass the next frame in the stream
108	MPEG2_FRAME_SKIPPED	Indicates that the current picture has been skipped from decoding in trick mode	Pass the next frame in the stream
109	MPEG2_REF_FRAME_SKIPPED	Indicates that the reference picture for P/B picture has been skipped under trick mode	Pass the next frame in the stream
110	MPEG2_NO_REF_TO_FLUSH	No more reference pictures held by the codec to provide in the flush call	All reference pictures have been given out by the codec
111	MPEG2_EXCESS_INPUT_BYTES	Entire input bytes have not been consumed by the codec	Pass the next frame in the stream
112	MPEG2_ALL_MBS_NOT_DECODED	Number of decoded MBs is lesser than the expected number of MBs in the picture	Pass the next frame in the stream